

# YAKIMA®

TAKE IT EASY™



YAKIMA

2022 PRODUCT GUIDE - STORE COPY

YAKIMA

PRODUCT GUIDE  
2022





Based in the Pacific NW, Yakima Products Inc. has been a pioneer of cargo and gear management solutions since 1979. We connect people with their passions to bring them closer to nature with our innovative, rugged and dependable products. Yakima Products, Inc. is headquartered outside of Portland, Oregon. For more information, visit [www.yakima.com](http://www.yakima.com)



# NEW PRODUCTS FOR 2022



**EXO OpenRange™**  
OUTDOOR COOKING STORAGE SYSTEM



**EXO OpenRange™ Deluxe**  
EXO OPENRANGE BUNDLE



**GateKeeper™**  
TRUCK BED TAILGATE PAD



**StageTwo™**  
PREMIUM TRAY HITCH BIKE RACK



**HangTight™ 4, 6**  
VERTICAL HANGING BIKE RACK



**EXO SYSTEM**

**YAKIMA®**  
TAKE IT EASY.



# CARRY EVERYTHING YOU NEED.

## THE EXO SYSTEM

Take more, take less, take exactly what you need in one simple package. Start with the EXO SwingBase, then add and adapt with multiple attachments that allow you to take all your gear. With over 20 possible combinations, the EXO System is ready for any adventure. Carry everything you need for whatever your weekend has in store.

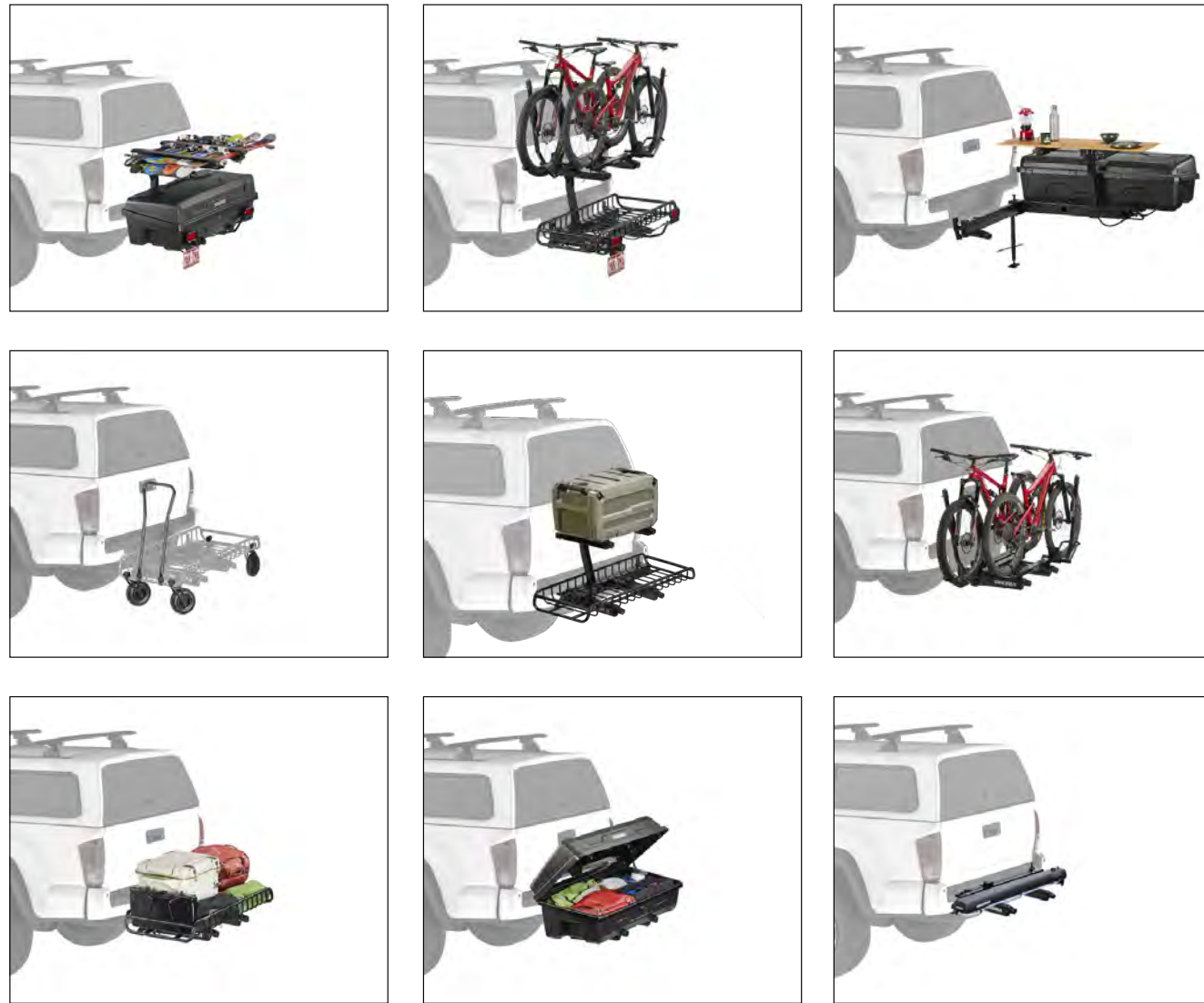

# EXO SYSTEM

Turn your hitch into a do-anything, go-anywhere multi-tool



### The Foundation

The EXO SwingBase™ is the launchpad for all EXO mounts and accessories. Fits into a 2" hitch receiver.



### Double Up the Capacity

Double the space with a second tier of accessible storage with the EXO TopShelf™.



### How It All Comes Together

The EXO SwingBase™ and EXO TopShelf feature a proprietary cleat system called the EXO Cleat. It allows the gear mounts to be easily interchanged without the need for tools. This is all done by two locking SpeedKnobs on each side of the articulating arms.



### Full Functionality

Once the EXO System is configured to the desired set-up, the entire system has the ability to swing away from the vehicle for trunk access. An included kickstand can be deployed if the user is keeping the system swung open to ensure a level work surface.





## EXO SwingBase™ EXO HITCH SYSTEM BASE

The EXO SwingBase takes your standard hitch and turns it into the ultimate foundation for hauling and organizing every piece of gear in your kit. It's the base to which all other EXO components attach. Simply leave it on your vehicle and change EXO components as your adventures adapt.

- Swings away from car with gear loaded to provide easy access to rear of vehicle
- Accessories install in seconds using the tool-free EXO Cleat system and locking SpeedKnobs
- Accessory arms fold in when not in use
- Fits 2" hitch receivers only
- Included HitchLock locks EXO SwingBase to vehicle
- Includes 2 extra SKS locks cores for use with EXO accessories

#8002715



Accessory arms fold in when not in use.



Fits 2" hitch receivers only.



Swings away from car with gear loaded to provide easy access to rear of vehicle.



Accessories install in seconds using the tool-Free EXO Cleat system and locking SpeedKnobs.

## EXO TopShelf™ SECOND LEVEL EXO SYSTEM BASE

Double your hitch capacity with a second tier of super accessible storage with the EXO TopShelf. Whether you're cycling and camping, skiing and hiking or simply needing to double your load, the EXO TopShelf can mix-and-match EXO accessories to make any adventure easier.

- Attaches to and requires EXO SwingBase to create a second level on your EXO Hitch system
- Rotates 180 degrees relative to EXO SwingBase for easy access to gear on lower level or to set-up base camp mode
- Accessories install in seconds using the tool-Free EXO Cleat system with locking SpeedKnobs
- Included HitchLock locks EXO TopShelf to EXO SwingBase
- Includes 2 extra SKS locks cores for use with EXO accessories

#8002716



Attaches to and requires EXO SwingBase to create a second level on your EXO Hitch system.



Includes a jack stand for base camp mode set-up.



Rotates 180 Degrees relative to EXO SwingBase for easy access to gear on lower level.



Accessories install in seconds using the tool-Free EXO Cleat system with locking SpeedKnobs.

## EXO LitKit LICENSE PLATE AND LIGHT KIT

Hardcore adventurers like keeping things safe on the road. EXO LitKit ensures you are street-legal when using the Yakima EXO System. Simply attach to the EXO SwingBase arms to keep your license plate and taillights visible, no matter your configuration.

#8002720







# EXO GearLocker™

## EXO SYSTEM CARGO MOUNT

The EXO GearLocker gives you the functionality of a legendary Yakima roof-top cargo box, but with hitch-mounted ease-of-access. Easy on-and-off makes it perfect for hauling gear from your car to the campsite, the beach or anywhere else you need your gear on-hand.

- Connects to the EXO SwingBase or EXO TopShelf in seconds using the EXO cleat system
- 10 Cubic Feet of Storage Space
- Wide-angle opening makes placing or finding your gear easy
- 100lb gear weight limit when mounted on EXO SwingBase
- 80lb gear weight limit when mounted on EXO TopShelf
- Tool-free, locking SpeedKnobs attach and lock EXO GearLocker to EXO SwingBase or EXO TopShelf
- Made in the USA

#8002718



Connects to the EXO SwingBase or EXO TopShelf.



Tool-free, locking SpeedKnobs attach and lock EXO GearLocker.



Wide-angle opening makes placing or finding your gear easy.



SKS Lock included for added gear security.

# EXO GearTotes

## COLLAPSIBLE TOTE

Make the most of your EXO GearLocker with the EXO GearTotes, collapsible, dividable totes that make it easy to stay organized from house to vehicle to destination and back again.

#8002719



# EXO GearWarrior™

## EXO SYSTEM BASKET MOUNT

When you need to transport coolers, firewood or bulky gear from your home to your vehicle to your destination, the EXO GearWarrior is where it's at. Simply attach it to your EXO SwingBase or EXO TopShelf, load up and get out. Add the available EXO WarriorWheels to turn the EXO GearWarrior into a handy wagon with wheels and a handle that can be attached while the EXO GearWarrior is still on your hitch.

- Connects to the EXO SwingBase or EXO TopShelf
- Weather-resistant, heavy-duty steel construction
- Tool-free, locking SpeedKnobs attach and lock EXO GearWarrior to EXO SwingBase or EXO TopShelf
- 250lb gear weight limit when mounted on EXO SwingBase w/out EXO TopShelf
- 110lb gear weight limit when mounted on EXO SwingBase w/EXO TopShelf installed
- 80lb gear weight limit when mounted on EXO TopShelf

#8002724



Connects to the EXO SwingBase or EXO TopShelf in seconds using the EXO cleat system.



250lb gear weight limit when mounted on EXO SwingBase w/out EXO TopShelf.



Tool-free, locking SpeedKnobs attach and lock EXO GearWarrior.



Weather-resistant, heavy-duty steel construction.

# EXO WarriorWheels

## WARRIOR BASKET CART KIT

We made hauling from home to vehicle to anywhere a snap with the EXO WarriorWheels — wheels and a handle that connect to your EXO GearWarrior, even while it's still on your hitch.

#8002712







## EXO DoubleUp™

### EXO SYSTEM BIKE MOUNT



The two-bike EXO DoubleUp attaches directly to the EXO SwingBase or to the second tier EXO TopShelf allowing room for an EXO GearLocker or EXO GearWarrior below. Either way, it's super easy access that accommodates anything you're riding — fat tires to road bikes and everything in between.

#8002722



Connects to the EXO SwingBase or EXO TopShelf in seconds using the EXO cleat system.



Fits most bikes, including fat-tire, mountain, road, hybrid, women's specific, BMX, kids' bikes.



Tool-free, locking SpeedKnobs attach and lock EXO DoubleUp.



StrongArm hook secures bike at wheels, protecting painted surfaces and carbon frames.



## EXO SnowBank™

### EXO SYSTEM SNOW MOUNT

Getting your skis and boards to the slopes has never been easier with the new EXO SnowBank. Pair it with an EXO GearLocker and you have customizable storage for everything you need. Carry up to five pairs of skis or four snowboards on the back of your vehicle — enough for your entire crew.

#8002723



Connects to the EXO SwingBase or EXO TopShelf in seconds using the EXO cleat system.



DoubleJoint hinge expands for easy use with thick skis and boards.



Tool-free, locking SpeedKnobs attach and lock EXO SnowBank.



Large button makes it easy to open with gloves or mittens on.



## EXO BackDeck™

### EXO SYSTEM TABLE TOP MOUNT

Whether you're tinkering on your gear, prepping a meal for your crew, or mixing drinks for a night of fun, the EXO BackDeck is the perfect solution, turning your EXO system from gear hauler to working surface to bar top in seconds. When you're done, simply stow it and get back on the road.

#8002721



Connects to the EXO SwingBase or EXO TopShelf in seconds using the EXO cleat system.



50" x 17" UV protected bamboo work surface.



Included bag protects the tabletop when not in use and makes for easy transport.



Tool-free, locking SpeedKnobs attach and lock EXO BackDeck.



## RoadShower™

### PORTABLE PRESSURIZED WATER STORAGE

Combined with EXO RoadShower Kit, the RoadShower is your trusty sidekick for the convenience of pressurized water in the middle of nowhere.

4G #8004109  
7G #8004110  
EXO RoadShower Kit #8004112



Connects to the EXO SwingBase or EXO TopShelf in seconds using the EXO cleat system.



Tool-free, locking SpeedKnobs attach and lock RoadShower.



## EXO RoadShower Kit EXO ADAPTER KIT

The EXO RoadShower Kit lets you attach the RoadShower 4G and 7G to your EXO system giving you more mounting options for your RoadShower.

#8004112





## EXO OpenRange™ OUTDOOR COOKING STORAGE SYSTEM

The EXO OpenRange unit design allows for organizing and transporting cooking gear. It easily opens into a fully functional work station, making it easy to prep, cook, and serve from the same spot. EXO OpenRange seamlessly attaches to the EXO System for easy transport, and can be deployed into kitchen mode right from your vehicle, or can be relocated to a table or Leg Kit for stand-alone use.

- Connects to the EXO SwingBase or EXO TopShelf in seconds using the included EXO cleat system
- Durable rotomolded enclosure with a rubber door seal keeps your gear fully protected from weather, dust, and critters
- Fold down front door allows easy access to your gear and can be used as a prep surface
- Internal shelf and integrated utensil drawer help to organize your cooking and camp gear
- 85 liters (90 quarts) of internal storage space, and rated to carry up to 50 lb. of gear
- Includes SKS locking latches to secure your gear

#8007447



Seamlessly attaches to the EXO System for smooth transport and deployment.



Opens into a fully functional work station with an integrated utensil drawer and internal shelf.



Backboard Organizer keeps items organized and workspace clear of clutter.



Keep gear fully protected with SKS locking latches, and ruggedized roto molded enclosure.

LEARN MORE AT [YAKIMA.COM](http://YAKIMA.COM)



## OpenRange™ Wood Side Table WOOD SIDE TABLE

Bamboo wood side table expands your cook zone with valuable work surface. 13" x 27" bamboo table is UV protected with a premium finish. Fits inside EXO OpenRange for easy transporting.

#8007451



Includes plastic cutting board and collapsible wash basin that nests into the table.



Attaches to EXO OpenRange for expanded cooking work space.



## OpenRange™ Metal Side Table METAL SIDE TABLE

Metal side table for cooking with stoves of all sizes. 16" x 31" powder-coated steel surface is heat resistant and perfect for stove use.

#8007457



Metal rod supports propane camp stove tanks or doubles as a towel rack.



Attaches to EXO OpenRange for expanded cooking space .







## OpenRange™ Leg Kit

### FREE STANDING LEG KIT

This sturdy leg kit attaches to the bottom of EXO OpenRange storage box, so you can set up to cook anywhere you want. Telescoping legs provide height adjustment from 20" - 33" with micro-adjustment for unlevel ground.

#8007449



Telescoping legs provide height adjustment from 20" to 33".

Provides a stable base for EXO OpenRange Storage Box.



◀ LegKit not included



## EXO OpenRange™ Deluxe

### EXO OPENRANGE BUNDLE

The EXO OpenRange Deluxe design allows for easy organizing and transporting of cooking gear. It opens into a fully functional work station, making it easy to prep, cook, and serve from the same spot. EXO OpenRange Deluxe seamlessly attaches to the EXO System for easy transport, and can be deployed into kitchen mode right from your vehicle, or can be relocated to a table or Leg Kit for stand-alone use.

#### INCLUDES

- ▶ EXO OpenRange, Lantern Hook, Utensil Drawer, Backboard Organizer, Collapsible Washbasin, Drain Hose, Hanging Fuel Canister Pouch, Fuel Hose, Wood Side Table, Cutting Board, Metal Side Table, CookOut™ 2-Burner Camp Stove

#8007448



## CookOut™ Stove

### 2-BURNER PROPANE CAMP STOVE

A reliable and high-quality 2-burner propane stove with push-button ignition for easy cooking in the outdoors. Easily integrated into the EXO OpenRange System. Pair with the OpenRange Metal Side Table to expand your work surface.

#8007452



Precision control valves for easy adjustment of burner heat, and push-button piezo ignition.

Includes fuel regulator pipe for connection to common 1lb propane fuel canisters.



**EXO OpenRange™**  
Outdoor cooking Storage System



**CookOut™**  
2-Burner Propane Camp Stove



**Stove Accessory**  
Hanging fuel canister pouch and fuel hose



**OpenRange Metal Side Table**  
Work surface and ideal stove location



**OpenRange Wood Side Table**  
Work surface and cutting board



**Wash Basin**  
Collapsible wash basin and drain hose



## EXO Product Size and Weights

Dimensions and weights for EXO products and accessories.

	Product Weight (No gear)	Dimensions (LxWxH)
<b>EXO GearLocker</b>	27.8 lbs.	60 x 23 x 16 in
<b>EXO GearWarrior</b>	22 lbs.	60 x 23 x 6.5 in
<b>EXO DoubleUp</b>	37.2 lbs.	26.6 x 72 x 7 in
<b>EXO BackDeck</b>	10.8 lbs.	17 x 50 x .75 in
<b>EXO SnowBank</b>	13.25 lbs	21.5 x 32 x 4.5 in
<b>EXO SwingBase</b>	68.5 lbs.	34 x 49 x 9.5 in
<b>EXO TopShelf</b>	33.5 lbs.	31 x 25 x 26.6 in
<b>EXO WarriorWheels</b>	18.5 lbs.	64 x 21 x 39 in (Installed on basket)
<b>EXO LitKit</b>	5 lbs.	24.5 x 50 x 10 in
<b>EXO GearTotes</b>	4 lbs.	18 x 13.5 x 9.5 in
<b>EXO OpenRange</b>	37 lbs.	31 x 18 x 18W in



**NOTE:** The height shown is from bolt hole to highest point of accessory.

## EXO Weight Capacity With Gear

Weight rating for EXO accessories with gear depends on which level it's paired with, top or base. The total weight on the hitch receiver maxes out at 350 lbs.

	Mounted on EXO SwingBase Only	Mounted on EXO SwingBase With EXO TopShelf Installed	Mounted on EXO TopShelf
<b>EXO GearLocker</b>	100 lbs. On Road 60 lbs. Off Road	100 lbs. On Road 60 lbs. Off Road	80 lbs. On Road 48 lbs. Off Road
<b>EXO GearWarrior</b>	250 lbs. On Road 150 lbs. Off Road	100 lbs. On Road 60 lbs. Off Road	80 lbs. On Road 48 lbs. Off Road
<b>EXO DoubleUp</b>	50 lbs. per bike On Road 30 lbs. per bike Off Road	Not Recommend	40 lbs. per bike On Road 24 lbs. per bike Off Road
<b>EXO BackDeck*</b> <small>Use only permitted when the vehicle is not in motion.</small>	80 lbs.	80lbs.	80 lbs.

	Weight Limit
<b>EXO GearTotes</b>	50 lbs.
<b>EXO WarriorWheels</b>	110 lbs.



## ROOF RACKS

**YAKIMA**  
TAKE IT EASY.



# ROOF RACKS

CUSTOMIZE YOUR ADVENTURE MOBILE

## Customize Your Vehicle

ON YOUR MOBILE DEVICE:

GO.YAKIMA.COM

DESKTOP:

YAKIMA.COM



## HOW TO BUILD YOUR ROOF RACK



### YOUR VEHICLE DETERMINES THE TOWER

The tower is what attaches the roof rack to the vehicle. Because not all roofs are the same, we offer 4 different towers to accommodate just about every roof. Some towers require a 'clip' system to secure it. **ROOF TYPES:**

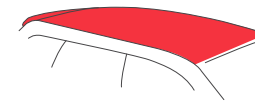

#### Naked

A bare roof with no designated attachment points.

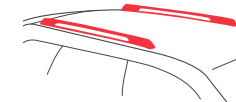

#### Raised Rail

Two raised rails that run parallel to the doors. There is enough of a gap that you could slide your hand underneath.



#### Flush Rail

Two flush rails that run parallel to the doors. You cannot slide your hand underneath.

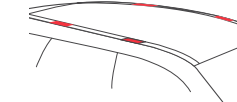

#### Fixed Point

Four hidden attachment points that are usually disguised by a cover or plastic door. Can be found on some flush rails, or raised rail roofs.

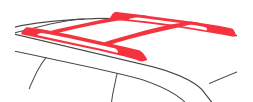

#### Factory

Crossbars and side rails that came pre-installed on the vehicle from the dealership.



### YOUR STYLE DETERMINES THE CROSSBAR

We all like things a little bit differently than the other. So there are 4 crossbar options to choose from varying from material to use-case, color and length. They are JetStream Black, JetStream Silver, HD Bar, CoreBar and RoundBar.



### YOU LIFESTYLE DETERMINES THE MOUNTS

After your roof rack is installed it's time to add accessories and gear mounts. Such as, SKS locks or a wind fairing to reduce wind noise.





# ROOF RACK TOWERS

CONNECT YOUR ROOF RACK TO YOUR VEHICLE

## StreamLine™ Towers

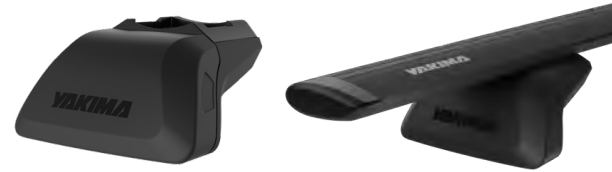

### BaseLine™ Towers

No rails? No problem. The versatile design adjusts to a variety of vehicle roofs for a sleek and secure fit.

- For use on vehicles with naked roofs
- Risk-free installation with included torque tool
- Bar angle adjusts for aerodynamic fit
- Easily locks to vehicle with our SKS system (sold separately)
- To be used with vehicle-specific BaseClips

4 PACK #8000162  
 2 PACK #8000183  
 Add 4 SKS Locks #8007204

BaseClips – Vehicle-Specific



### SightLine™ Towers

Strong and versatile, SightLine Towers attach easily and have a sleek design that complements your vehicle's aerodynamic attitude.

- For use on vehicle roofs with flush side rails
- Risk-free installation with included torque tool
- Bar angle adjusts for aerodynamic fit
- Easily locks to vehicle with our SKS system (sold separately)
- To be used with vehicle-specific SightClips

4 PACK #8001635  
 Add 4 SKS Locks #8007204

SightClips – Vehicle-Specific



### SkyLine™ Towers

Create a mega-versatile and easy-to-use system that handles your unique personality and extensive range of gear.

- For use on vehicle roofs with fixed points or tracks
- Risk-free installation with included torque tool
- Bar angle adjusts for aerodynamic fit
- Easily locks to vehicle with our SKS system (sold separately)
- To be used with vehicle-specific Landing Pads

4 PACK #8000163  
 2 PACK #8000184

Add 4 SKS Locks #8007204

Landing Pad – Vehicle-Specific



### TimberLine™ Towers

TimberLine Towers expand your carrying capacity and deliver maximum rooftop versatility. Secure, quiet, and simple to install.

- For use on vehicle roofs with raised side rails
- Risk-free installation with included torque tool
- Easily locks to vehicle with our SKS system (sold separately)

4 PACK #8000164  
 2 PACK #8000185

Add 4 SKS Locks #8007204



# ROOF RACK CROSSBARS

THE MOUNTING POINT FOR YOUR GEAR



● ● Available colors

### JetStream™

Aluminum crossbars that are exceptionally aerodynamic, strong, lightweight, and really quiet. T-slot compatible with SmartFill™ infill for efficient airflow. Sold as a pair.

- 50" SM #8000425
- 60" MD #8000426
- 70" LG #8000427
- 50" SM #8000428
- MD #8000429
- LG #8000430



### HD Bar

Our burliest crossbar ever. Engineered aluminum construction provides superior support and is built with integrated tie-down points and T-slot compatibility. Sold as a pair.

HD Bar works with all StreamLine Towers with the addition of the HD Bar SL Adapter, Sold separately #8003541

- 55" SM #8001156
- 60" MD #8001157
- 68" LG #8001158
- 78" XL #8001159



### CoreBar™

The only aerodynamic crossbars made from roll-formed galvanized steel, and vinyl-wrapped to prevent corrosion. Heavy on the load, quiet on the road. Sold as a pair.

- 50" SM #8000421
- 60" MD #8000422
- 70" LG #8000423



### RoundBar™

The Yakima legacy crossbar. Roll-formed galvanized steel, and vinyl-wrapped to prevent corrosion. Sold as a pair.

RoundBar works with all StreamLine Towers with the addition of the RoundBar SL Adapter, Sold separately #8003536

- 48" SM #8000408
- 58" MD #8000409
- 66" LG #8000410
- 78" XL #8000411



## ROOF RACK SPECIALTY



### 1A Raingutter™ Towers

Anchor these to your old-school rain gutters, then add our classic RoundBars to create a secure, versatile rooftop system for your retro ride.

- Specifically designed to clamp to rain gutters
- Works with the classic Yakima RoundBar only
- Die-cast interior creates a durable and sturdy anchor
- Easily locks to your vehicle with our SKS system (sold separately)

4 PACK #8000101

4 PACK 1A HiRise Spacers #8001101

Add 4 SKS Locks #8007204

## ROOF RACK ACCESSORIES

### WindShield™

#### ROOF RACK WIND FAIRING

Noise-dampening wind fairing that attaches to most crossbars.

34" #8005016

40" #8005017

46" #8005018

52" #8005019



### Same Key System Locks

#### MULTIPLE RACKS, ONE KEY

SKS Locks allow you to lock everything from your roof rack to your bike rack with the same key.

2 PACK #8007202

4 PACK #8007204

6 PACK #8007206

8 PACK #8007208



## ROOF RACK ADAPTERS AND MORE



### HD Bar SL Adapter

Attaches StreamLine Towers to the HD Bar crossbars.

4 PACK #8003541



### RoundBar™ SL Adapter

Attaches StreamLine Towers to the classic RoundBar crossbars.

4 PACK #8003536



### LockNLoad™ SL Adapters

Adapters to attach LockNLoad platform directly to TimberLine or SkyLine Towers.

2 PACK #8005042



# ROOF RACKS CUSTOM

SOLUTIONS TO INCREASE VERSATILITY



Permanent Landing Pad



Track Kit Over Cap

## PERMANENT BASE

Best for truck caps, tent trailers, RVs or vans, this permanently attached base provides mounting points for SkyLine towers.

### Landing Pad 6

For fiberglass roof installation or roofs with underside access.

2 PACK #8000226

### Landing Pad 7

For sheet metal roof installation or roofs with no underside access.

2 PACK #8000227

### Landing Pad 21

For permanent installation into the roof ditch for up to a 220-lb. load rating.

4 PACK #8000227

## 1A RAINGUTTER BRACKETS

### SideLoader™ Bracket

Fits in the space between the top of a truck shell and the side window.

2 PACK #8008002

### Bolt TopLoader™ Bracket

Allows use of 1A Raingutters on roofs without rain gutters.

2 PACK #8008005

## TRACK KITS

A track system offers easy connectivity and a low profile when towers are removed. Combine Yakima Tracks with SkyLine Towers plus a couple of sets of Landing Pad 1 and you have a versatile, adjustable base for your rack system.

### Sheet Metal Install

54" Tracks with PlusNuts #8001127

### Sheet Metal Install

42" Tracks with PlusNuts #8001126

### Fiberglass Install

60" Tracks with CapNuts #8001135

### Fiberglass Install

54" Tracks with CapNuts #8001138

## HD TRACKS

Allow Yakima Overhaul HD or OutPost HD or Skyline and HD Bars to be installed on HD Tracks. Perfect for overlanding trailers, truck bed rails, and other custom applications. Up to 500lb load limit.

72" HD Track with CapNut #8001633

60" HD Track with CapNut #8001632

54" HD Track with CapNut #8001631

Learn more at  
[yakima.com/custom-install](http://yakima.com/custom-install)

CURRENT PRICING AVAILABLE AT YAKIMA.COM





# ROOF RACKS PLATFORM

THE MOST VERSATILE OPTIONS FOR ANY ADVENTURE



## LockNLoad™ HEAVY-DUTY ROOF RACK PLATFORMS

Build-out your vehicle to be a true adventure rig—whether to get to the local trailhead or miles from civilization. Designed and thoroughly tested in the rugged Australian Outback, the LockNLoad roof rack platform is a blank slate, ready for you to customize to your needs. Integrated T-slots throughout allow quick and easy attachment of our new LockNLoad accessories. Horizontal slats are designed to attach bike, kayak, surf, ski mounts, or even one of our SkyRise™ rooftop tents. The off-road rated LockNLoad is available in 6 sizes so there's a platform sized for your vehicle that's ready to explore.

**Available in 6 sizes for the perfect fit.**  
VISIT [YAKIMA.COM](http://YAKIMA.COM) TO MATCH A PLATFORM WITH YOUR VEHICLE.

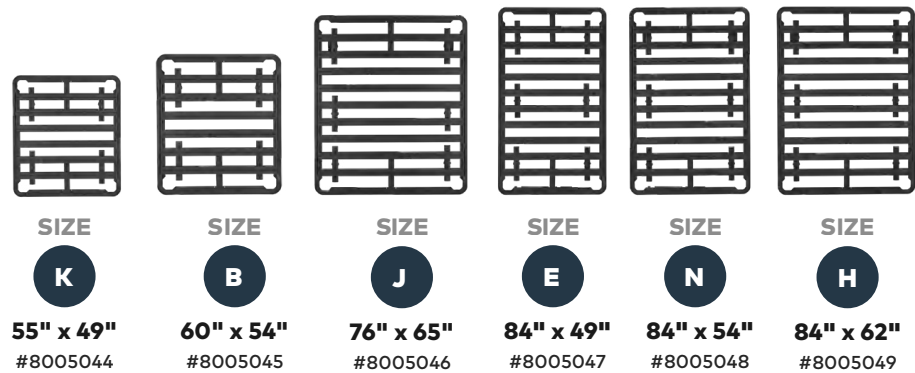

Integrated T-slots in every slat and outer frame, for simple attachment of T-slot accessories.



Durable and stylish corrosion-resistant aluminum construction and textured black powder-coat finish.



Built-in fairing reduces wind noise.



# LOCKNLOAD™ ACCESSORIES

CUSTOMIZE YOUR ADVENTURES



Meeting our tough Off-Road Rated standards, the LockNLoad Accessories Collection provides more options to quickly and easily customize a sport, utility, or off-road vehicle's rooftop.



**High Lift Jack Holder**  
CARRIES 1 HIGH LIFT JACK  
Features lock loop for owner's lock.  
#8005033



**Corner Brackets**  
T-SLOT GEAR BRACES  
Includes 4 corners and eye bolts.  
#8005036



**Spare Wheel Holder**  
CARRIES 1 WHEEL  
100-lb load capacity.  
#8005032



**Jerry Can Holder**  
CARRIES 1 JERRY CAN  
Ratchet straps secure can.  
#8005038

**Perimeter Rail Kits**  
RAISED RAILS FOR BRACING AND TYING DOWN CARGO  
Full-length T-slot channels for T-slot accessories.



Visit [yakima.com](http://yakima.com) to build your custom LockNLoad™ Platform with perimeter rails.



# Attaching the LockNLoad

There are 2 ways to attach the LockNLoad platform to your vehicle. One is to utilize your existing roof rack and attach it directly to the crossbars or, build LockNLoad as a roof rack and attach directly to the towers.

## Option ① Attach Directly to Existing Roof Rack or Truck Rack Crossbars

The LockNLoad Crossbar Clamps allow you to attach the platform to your existing roof rack or truck rack. It is compatible with all Yakima crossbars as well as many other brands.

### HOW?

The clamps attach to the Platform mounting blocks then are simply bolted to the lower half of the clamp around the crossbar.

### WHAT TO BUY:

- **1 LockNLoad Platform**  
Check what size that fits your vehicle:  
[yakima.com/locknload-platform](http://yakima.com/locknload-platform)
- **Sizes - K&B - 2 sets of LockNLoad Crossbar Clamps\***
- **Sizes - J, E, N, & H - 3 sets of LockNLoad Crossbar Clamps\***

\* For increased weight rating see Weight Rating and Application Chart for details.

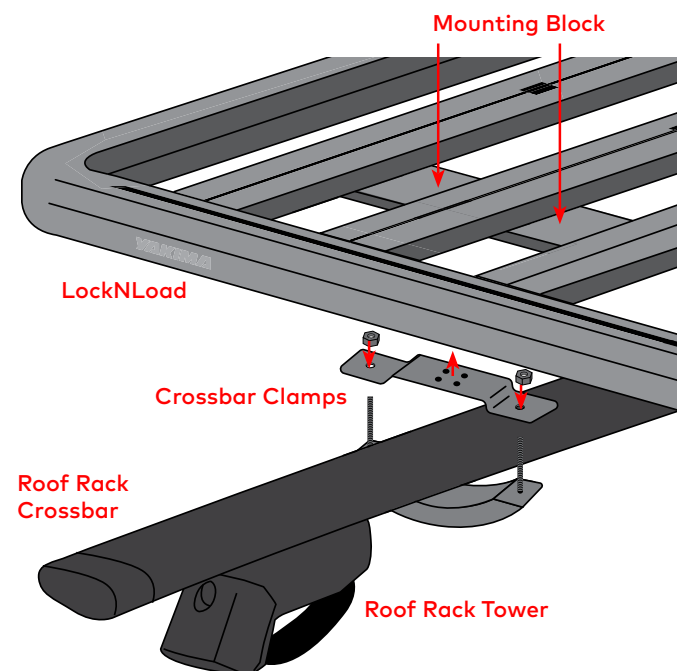

## Option ② Attach Directly to Roof Rack Towers

The LockNLoad SL adapter allows you to connect the platform to a Yakima StreamLine Tower. The platform takes the place of the roof rack crossbars. The SL Adapter is only compatible with TimberLine and SkyLine towers.

### HOW?

The Adapter sits in the tower and is bolted together, then the tower + adapter are bolted to the platform.

### WHAT TO BUY:

- **1 LockNLoad Platform**  
Check what size fits your vehicle:  
[yakima.com/locknload-platform](http://yakima.com/locknload-platform)
- **Sizes - K&B - 2 sets of LockNLoad SL Adapter\***
- **Sizes - J, E, N, & H - 3 sets of LockNLoad SL Adapter\***

\* For increased weight rating see Weight Rating and Application Chart for details.

- **SkyLine or TimberLine Towers** - Find your vehicle fit at [yakima.com/locknload-platform](http://yakima.com/locknload-platform)

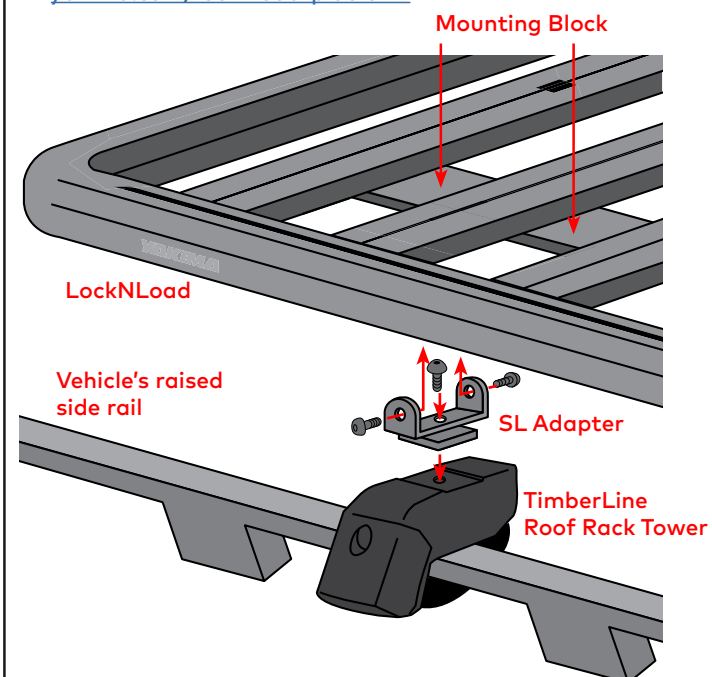

These are not instructions for installation.



BIKE



## Hitch Bike Rack Styles



### Tray-Style

**LOAD BIKES QUICKLY AND EASILY**  
Fuel efficient & easy to load bikes at rear of vehicle.  
Most flexibility to arrange bikes for safe transport.  
Tilts with bikes loaded for easy hatch access.



### Tilt-Style

**TRIED AND TRUE, MINIMALIST**  
Secures bikes at the top tube.  
Tilts forward with bikes unloaded for hatch access.

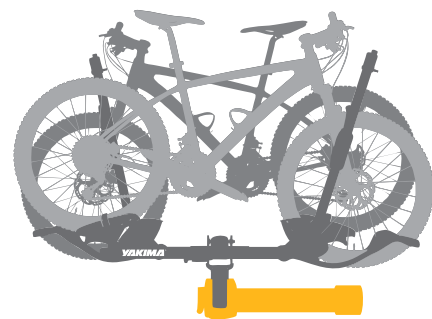

### Swing Adapter

**TURN YOUR 2" TILT, TRAY, OR VERTICAL RACK INTO A SWING-STYLE RACK.**  
Adapter Only. Hitch product sold separately.  
Find compatible hitch products at [yakima.com/backswing](http://yakima.com/backswing).

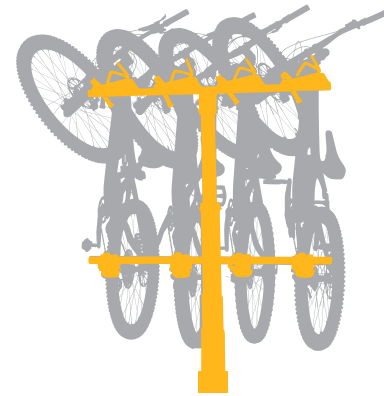

### Vertical-Style

**SHUTTLE YOUR BUDDIES OR THE FAM**  
Saves space by organizing bikes vertically.  
Tilts away from vehicle for hatch access.



### Swing-Style

**EASY ACCESS TO YOUR TRUNK**  
Secures bikes at the top tube.  
Swings away with bikes loaded for full hatch access.

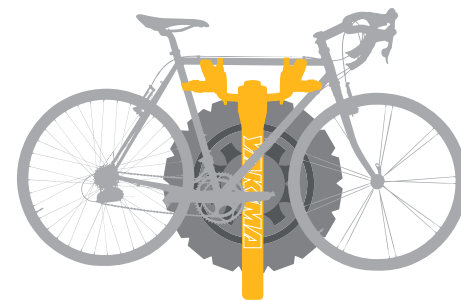

### Spare Tire

**JEEP LOVERS LOOK HERE**  
Spare tire mount and Hitch Extender option available.  
Hitch product sold separately(Hitch Extender).



## StageTwo™

### PREMIUM TRAY HITCH BIKE RACK



The StageTwo is built to carry your valuable steeds anywhere you need to go, securely and in style. The StrongArm hook quickly secures your bike while the stadium seating tiered architecture increases ground clearance on rutted trails or steep driveways. An offset tray design further minimizes bike to bike interference and maximizes functionality.

- Tiered and adjustable bike trays minimize bike to bike interference and maximize ground clearance
- StrongArm™ hook secures bike at wheels, protecting painted surfaces and carbon frames
- Convenient remote tilt lever for easy rear of car access
- Tool-free locking SpeedKnob for secure installation and removal
- Offset Trays for extra bike to bike clearance
- E-bike compatible, up to 60lbs per bike

2 INCH ANTHRACITE #8002725  
2 INCH VAPOR #8002740  
1.25 INCH ANTHRACITE #8002726



- Fits 20" to 29" wheel sizes,
- Tires up to 3.25" wide, and up to 5" wide with StageTwo Fat Bike Kit



Tiered and adjustable bike trays minimize bike to bike interference and maximize ground clearance.



Tilts down with bikes loaded for trunk access.



Convenient remote tilt lever for easy rear of car access.



Tool-free locking SpeedKnob for secure and simple installation and removal.

## STAGETWO +2

### ADD-ON PREMIUM TRAY HITCH BIKE RACK

Adding on the StageTwo +2 lets you double your capacity to four bikes, each carried securely and in style.

For use on StageTwo 2" only.

ANTHRACITE #8002727  
VAPOR #8002741





## STAGETWO ACCESSORIES



### SafetyMate™ STAGETWO LIGHTING AND PLATE KIT

SafetyMate ensures you are street-legal when using the StageTwo and StageTwo +2. Keep the clean lines and style of the StageTwo family going with the clean LED Lightbar and internal electrical routing.

#8002738



### RampUp™ STAGETWO RAMP KIT

No awkward loading here. Loading heavy bikes on the StageTwo family of racks is no problem with the RampUp, just lock the ramp in place and roll your bike up onto the tray.

#8002737



### Fat Bike Kit STAGETWO FAT BIKE KIT

Fat bikes fit fine with long wheel straps to accommodate fat bikes on StageTwo and StageTwo +2.

#8002735



## HoldUp™ TRAY HITCH BIKE RACK



A true Yakima classic. Its beefed-up arm pivot makes it stronger than ever and the increased side-to-side adjustability reduces the chance for bike-to-bike interference. It's a road trip companion for life. It even tilts down with bikes loaded for easy rear-of-vehicle access.

2 INCH #8002443  
1.25 INCH #8002445



- Fits 20" to 29" wheel sizes,
- Tires up to 3" wide, and bikes up to 60 lbs.



Integrated lock secures bike to the rack.



Adjustable trays.



## HOLDUP +2 HOLDUP HITCH BIKE RACK EXTENSION

Carry two additional bikes on the HoldUp. For use on HoldUp 2" only.

#8002446



## HoldUp™ EVO PREMIUM TRAY HITCH BIKE RACK



Rugged, proven, and super-easy to use, this next-gen HoldUp EVO includes an easy-access tilt mechanism and KickStart™ foot pedal, our SpeedKnob™ for tool-free installation, and Fat Bike compatibility. Expansive side-to-side adjustment delivers superior clearance, and the StrongArm hook secures the bikes at their wheels.

2 INCH #8002479  
1.25 INCH #8002480



- Fits 20" to 29" wheel sizes,
- Tires up to 3" wide, and bikes up to 60 lbs.



Fits road, mountain, fat tire, and kids bikes.



Locking SpeedKnob™ provides easy, tool-free attachment.



## HOLDUP EVO +2 HOLDUP EVO HITCH BIKE RACK EXTENSION

Carry two additional bikes on the HoldUp EVO. For use on HoldUp EVO 2" only. #8002482

LEARN MORE AT YAKIMA.COM



## SingleSpeed™ SINGLE BIKE TRAY HITCH RACK



Fast, light, and great for solo travel, the SingleSpeed holds virtually any kind of bike tight and is super-easy to install and remove—great for spur-of-the-moment rides.

#8002481



Integrated lock secures bike to the rack.



Locking SpeedKnob™ provides easy, tool-free attachment.



- StrongArm design secures bike at wheels, protecting paint and carbon frames
- Accommodates disc brakes, through axles, Boost hubs, and full suspension
- Weighs in at just 20 lbs.

- Fits 20" to 29" wheel sizes,
- Tires up to 4.8" wide, and bikes up to 40 lbs.

CURRENT PRICING AVAILABLE AT YAKIMA.COM





## OnRamp™ E-BIKE TRAY HITCH RACK



Say goodbye to awkward loading options, and hello to your e-bike's new best friend. The OnRamp blends simple, efficient design with secure performance, to create a no-compromise rack to ease the challenge of carrying heavier bikes.

2 INCH #8002706  
1.25 INCH #8002707

- Fits 20" to 29" wheel sizes.
- Tires up to 29x3.25" and up to 27.5x 4.5" wide tires with the FatStrap Kit (sold separately)



Engineered to carry 2 bikes up to 66-lbs each.



Integrated ramp for easy, roll-on loading, and stows away neatly.



Articulating cradles adapt to the shape of the bike frame and hold it securely in place.



The removable ramp stashes away at the back of the rack.



## HITCH TRAY RACK COMPARISON

### Tray Racks

	Bike Capacity	Hitch Size	Locks To Vehicle	Locks Bikes	Folds Up	Tilts Away	StrongArm™	SpeedKnob™	No Frame Contact	Fits Fat Bikes	E-Bike Friendly	Backswing Friendly	RV Approved
<b>StageTwo™</b> Add StageTwo+2 to carry 4 bikes	2 or 4	2" and 1.25"	✓	✓	✓	✓	✓	✓	✓	With StageTwo Fat Bike Kit #8002735	✓	✓	✓
<b>OnRamp™</b> Integrated loading ramp	2	2" and 1.25"	✓	✓	✓	✓				With Addition of FatStraps #8002714	✓	✓	2" ONLY
<b>SingleSpeed™</b>	1	2" and 1.25"	✓	✓			✓	✓	✓			✓	
<b>HoldUp™</b> Add HoldUp+2 to carry 4 bikes	2 or 4	2" and 1.25"	✓	✓	✓	✓	✓	✓	✓		✓	✓	2" ONLY
<b>HoldUp™ EVO</b> Add EVO+2 to carry 4 bikes	2 or 4	2" and 1.25"	✓	✓	✓	✓	✓	✓	✓		✓	✓	2" ONLY



## HangTight™ VERTICAL HANGING BIKE RACK



All your bikes, all at once. The HangTight is designed for versatility, built to handle adventures of all sorts, and won't blink at anything from kids to fat bikes to road to mountain bikes and everything in between. With fully padded cradles that support each bike by the handlebars, it serves up a shuttle-ready blend of stability and ease of use. The HangTight will get your bikes to the ride and back home safely no matter if your crew is a mix of all-mountain shredders or simply a family headed out for two-wheeled exploration.

4 BIKE #8002742 | Compatible with BackSwing  
6 BIKE #8002743



Securely supports most road, mountain, kids, and cruiser bikes by the handlebar.



Tilts forward for easy access to the trunk.



Fully padded cradles protect your handlebars, including carbon bars.



Foot-operated tilt mechanism makes it easy to access the rear of the vehicle.



Compatible with BackSwing, swing away hitch adapter



Compatible with BackSwing, swing away hitch adapter



# HangOver™

## VERTICAL HANGING MOUNTAIN BIKE RACK



Perfect for tour operators, group rides, and big families. Constructed of heavy-duty steel, our first-ever vertical bike rack safely hauls up to six mountain bikes to the trailhead. We designed and tested it in the lab and on the road to meet our demanding Yakima standards. The easy-to-operate tilt mechanism with two adjustable mast angles keeps your bikes from bumping into your car, truck, or SUV and makes accessing the tailgate a breeze. Available in 4-bike or 6-bike options, the HangOver's vertical orientation carries more bikes in less space. Get ready to session!

4 BIKE #8002484 | Compatible with BackSwing  
6 BIKE #8002485



Foot-operated tilt mechanism changes rack position for easy loading and unloading.



Securely supports bikes by the fork crown; fits suspension-fork bikes only.



Rotating wheel cup accommodates bikes with various wheelbases.

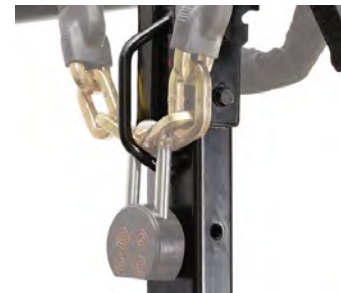

Add your own bike lock to the integrated lock loop for greater bike security.

LEARN MORE AT YAKIMA.COM



## HITCH VERTICAL RACK COMPARISON

### Vertical Racks

	Bike Capacity	Hitch Size	Locks To Vehicle	Foot Operated Tilt	Accommodates Locking Cable	Secures bike by Suspension Fork	Secures bike by Handlebar	BackSwing Friendly	Fits Fat Bikes	Fits Mountain Bikes	Fits Road Bikes
HangTight™	4 or 6	2"	✓	✓	✓		✓	✓ 4 BIKE ONLY	✓	✓	✓
HangOver™	4 or 6	2"	✓	✓	✓	✓		✓ 4 BIKE ONLY	✓	✓	



## BackSwing™

### HITCH RACK SWING ADAPTER



The BackSwing turns your HoldUp EVO—and almost any other 2" hitch rack or basket—into a swing-style rack, letting you easily access gear, food, and Fido with your bikes still loaded.

#8002483



Easily swings away 90° and locks into place.



250-lb. maximum load capacity.

CURRENT PRICING AVAILABLE AT YAKIMA.COM

#### Yakima Rack Compatibility – 250-lb. weight limit

HangOver 4
HangTight 4
StageTwo 2" & StageTwo +2
HoldUp EVO 2" & HoldUp EVO +2
HoldUp 2" & HoldUp +2
OnRamp 2"
SingleSpeed
LongHaul(Vans and Passenger Vehicles Only)





## FullTilt™ PREMIUM TILT-AWAY HITCH RACK



Fully assembled out of the box makes install a snap with the AutoPin and locking SpeedKnob. Easy-to-use ZipStrips secure bikes and are fully removable for easy loading and unloading. Fully padded arms provide superior bike protection.

#8002463



Arms fold flat when not in use.



Easy hitch install with tool-free locking SpeedKnob™.



Tilts down for easy access to the trunk.



Adjustable ZipStrip cradles allow for the perfect fit between bikes.



## RidgeBack™ TILT-AWAY HITCH BIKE RACK



UpperHand control lever tilts the rack away from the vehicle for easy access, and folds flat for easy storage. ZipStrips secure your bike and are fully removable for easy loading and unloading.

2-BIKE #8002457

4-BIKE #8002458

5-BIKE #8002459



ZipStrip cradles secure bikes in place and prevent swinging.



Easy hitch install with tool-free locking SpeedKnob™.



Tilts down for easy access to the trunk.



Arms fold flat when not in use.



## FullSwing™ PREMIUM SWING-AWAY HITCH BIKE RACK



Swings easily away from the car with bikes loaded to provide access to the rear of the vehicle. Fully padded arms and adjustable cradles provide superior bike protection. Easy-to-use ZipStrips secure your bike and are fully removable for easy loading and unloading.

#8002465



ZipStrip cradles secure bikes in place and prevent swinging.



Easy hitch install with tool-free locking SpeedKnob™.



Locks bikes to rack with integrated bike lock.



Tilting lever allows the arms to fold flat when not in use.



## SpareRide™ SPARE TIRE MOUNTED BIKE RACK



Easily attaches to your rear-mounted spare tire and turns it into a bike rack. With a built-in locking feature that keeps the rack and your spare tire secure to the vehicle, the SpareRide is durable, stable, and secure for up to 2 bikes.

#8002599



Rubber tread protects your spare tire.



Easy install with tool-free locking SpeedKnob™.



Arms fold flat when not in use.



ZipStrip cradles secure bikes in place and prevents swinging.



## LongHaul™ PREMIUM RV-APPROVED HITCH BIKE RACK



Built for rugged long-distance RV travel, the LongHaul securely carries four bikes, is easy to use, and is a breeze to install and remove. Packed with features, the RoadTrip goes above and beyond. The arms fold flat when not in use, the built-in lock secures bikes, and the padded cradles with ZipStrips hold bikes in place. It even features a handy bottle opener.

#8002476



Locks bikes to rack with integrated bike lock.



Features a "bring-your-own-lock" threading point.



Arms fold flat when not in use.



ZipStrip cradles secure bikes in place and prevent swinging.

## What is an RV?

ANY REAR AXLE TO HITCH GREATER THAN 72" (183CM) IS AN RV AND ALL TRAVEL TRAILERS ARE RVS

Vehicle with hitch receiver

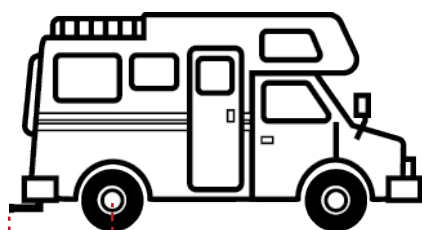

72" (183cm) or greater

Vehicle without hitch receiver or towball

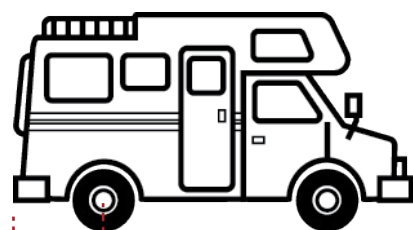

72" (183cm) or greater

Travel Trailer

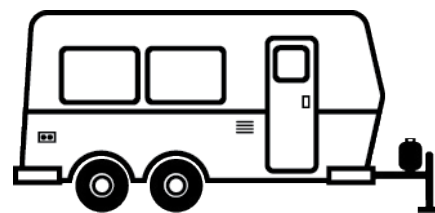

LEARN MORE AT YAKIMA.COM



## TILT/SWING HITCH RACK COMPARISON

### Tilt & Swing

	Bike Capacity	Hitch Size	Locks To Vehicle	Locks Bikes	Arms Fold Down	Trunk Accessibility	ZipStrips™	SpeedKnob™	Fully Padded Arms	Adjustable Cradles	RV Approved	BackSwing Friendly
<b>FullSwing™</b>	4	2"	✓	✓	✓	SWINGS AWAY	✓	✓	✓	✓		
<b>FullTilt™</b>	5	2" and 1.25"	✓	✓	✓	TILTS AWAY	✓	✓	✓	✓		
<b>RidgeBack™ (2, 4, 5)</b>	2, 4, or 5	2" and 1.25"	✓	With Addition of HandCuff #8002466	✓	TILTS AWAY	✓	✓		✓		
<b>LongHaul™</b>	4	2"	✓	✓	✓		✓				✓	With Vans and Passenger Vehicles ONLY



## StraightShot™ HITCH EXTENDER



Long gone are the days when your vehicle's spare tire gets in the way of an epic bike trip. This handy little extension adds 7.25 inches to a 2-inch hitch receiver. Giving you the clearance to attach just about any 2-inch bike rack. We're looking at you Broncos, Wranglers, and G-wagons.

#8002739

### Compatible with Yakima Hitch Racks:

- EXO SwingBase
- OnRamp 2"
- HoldUp EVO 2"
- HoldUp 2"
- HangTight 4
- HangOver 4
- Full Swing
- LongHaul
- RoadTrip



CURRENT PRICING AVAILABLE AT YAKIMA.COM





# HITCH RACK FIT TIPS

ENSURING THE PERFECT FIT ON A HITCH RECEIVER



## FIRST Determine Hitch Class and Size

Our hitch racks are designed and tested to work in Class I, II, III and IV receivers; we DO NOT fit Class V receivers.

To figure out which class your receiver falls into check the sticker on the side of the receiver. If there is no sticker present and the hitch came pre-installed, check the vehicle owner's manual under "Towing". Otherwise you can check with the dealership or manufacturer.

You will also need to determine what size hitch receiver you have. It will either be 2" wide or 1.25" wide. Measure the opening of the receiver.

## NEXT Use the Chart on next page to Match Products

Use the chart on the next page to determine what products are compatible with your hitch Class receiver.

## LAST Follow Fit Measurements

Because hitch receivers can be installed on the vehicle in many different ways it is important to check the provided fit measurements for compatibility. Find the products that fit your Class receiver and locate the A,B,C,D,E measurements that associate with the product.

Hitch Class	Size	Tongue weight Capacity	Tow weight Capacity
Class I	1 1/4"	Up to 200lbs	Up to 2000lbs
Class II	Usually 1 1/4"	Up to 350lbs	Up to 3500lbs
Class III	Usually 2"	Up to 800lbs	Up to 8000lbs
Class IV	2" or 2 1/2"	Up to 1000lbs	Up to 10000lbs

# HITCH RACK FIT MEASUREMENTS

Using the table chart, compare measurements to see which hitch racks will work with a specific vehicle. Measurement must be equal to or greater than the product measurement listed.

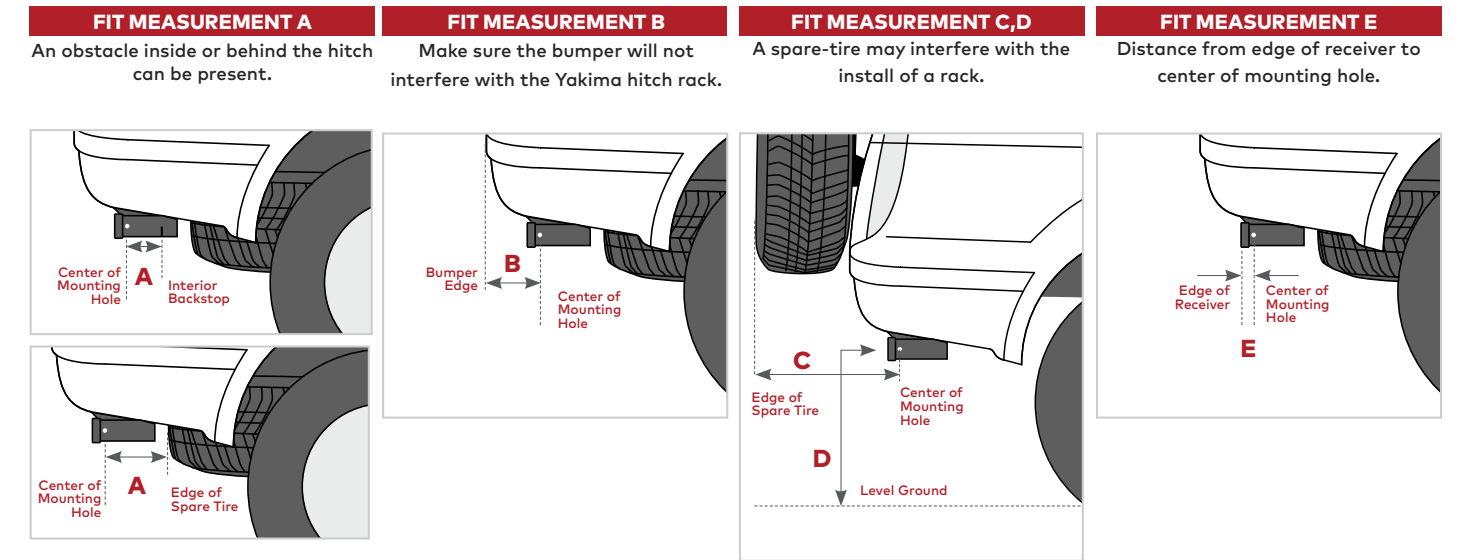

HITCH RACK	FIT MEASUREMENT					CLASS COMPATIBILITY			
	A	B	C	D	E	Class I	Class II	Class III	Class IV
OnRamp™ 2"	3" Min.	5 1/8" Max.	5 1/8" Max.	10 ★	1.5" Min.			✓	✓
OnRamp™ 1.25"	2" Min.	6 1/4" Max.	5 1/8" Max.	10 ★	1.5" Min.	◆	✓		
HangOver™ 6	3" Min.	8" Max.	13" Max.	12" Min.	1.5" Min.			✓	✓
HangOver™ 4	3" Min.	8" Max.	13" Max.	10" Min.	1.5" Min.			✓	✓
BackSwing™	2 7/8" Min.	8 1/4" Max.	6 1/2" Max.	10 ★	1.5" Min.			✓	✓
Dr.Tray™ 1.25"	3 3/4" Min.	6 1/4" Max.	9" Max.	10 ★	2.375" Min.			✓	✓
Dr.Tray™ 2"	2 7/8" Min.	9" Max.	9 3/4" Max.	10 ★	1.5" Min.			✓	✓
HoldUp™ 1.25"	2" Min.	9 1/2" Max.	10 1/2" Max.	10 ★	1.5" Min.		✓		
HoldUp™ 2"	2 7/8" Min.	9" Max.	9 3/4" Max.	10 ★	1.5" Min.			✓	✓
HoldUp™ 1.25"	2" Min.	9 1/2" Max.	10 1/2" Max.	10 ★	1.5" Min.		✓		
HoldUp™ 2"	2 7/8" Min.	9" Max.	9 3/4" Max.	10 ★	1.5" Min.			✓	✓
HoldUp EVO 1.25"	3" Min.	5" Max.	8 1/2" Max.	10 ★	2.375" Min.		✓		
HoldUp EVO 2"	3" Min.	5" Max.	8 1/2" Max.	10 ★	1.5" Min.			✓	✓
SingleSpeed™	1 5/8" Min.	7 3/4" Max.	12" Max.	10 ★	2.75" Min.	◆	✓	✓	✓
FullSwing™	3" Min.	8 3/4" Max.	6 3/4" Max.	10 ★	1.5" Min.			✓	✓
SwingDaddy™	3" Min.	6 1/2" Max.	6 3/4" Max.	10 ★	1.5" Min.			✓	✓
FourTimer™	2 3/4" Min.	13 3/8" Max.	14 1/2" Max.	10 ★	1.5" Min.			✓	✓
TwoTimer™	1 7/8" Min.	12 1/2" Max.	12 1/2" Max.	10 ★	2" Min.	◆	✓	✓	✓
FullTilt™ 4/5	1 3/8" Min.	9 1/2" Max.	9 3/4" Max.	10 ★	2.5" Min.	◆	✓	✓	✓
LongHaul™	3 1/8" Min.	4 3/8" Max.	4 1/2" Max.	10 ★	1.5" Min.			✓	✓
RoadTrip™	2 7/8" Min.	4 3/8" Max.	10 1/4" Max.	10 ★	1.5" Min.			✓	✓
RidgeBack™ 2/4/5	1 3/8" / 2 3/4" Min.	9.25 / 8" Max.	10" Max.	10 ★	1.5" Min.	◆		✓	✓
LiteRider™ 2/3	2 3/4" Min.	9" Max.	9" Max.	10 ★	2.75" Min.	◆	✓	✓	✓
DoubleDown™	2" Min.	9 1/8" Max.	9" Max.	10 ★	2" Min.	◆	✓	✓	✓
StageTwo™ 1.25"	2 3/4" Min.	6 1/4" Max.	8 1/2" Max.	10 ★	1.5" Min.			✓	✓
StageTwo™ 2"	3" Min.	5 3/8" Max.	8 1/2" Max.	10 ★	1.5" Min.			✓	✓
HangTight™ 6	3" Min.	8" Max.	13" Max.	12" Min.	1.5" Min.			✓	✓
HangTight™ 4	3" Min.	8" Max.	13" Max.	10" Min.	1.5" Min.			✓	✓

★ Measurement D is a recommended minimum on this product. Using Yakima hitch mounted bike racks on vehicles with a pinhole to ground distance less than the minimum recommended increases the risk of the bikes or rack striking the ground while in use.

◆ Due to variations in Class I hitch receivers, some Class I receivers may not be able to accept this product. Please refer to Fit measurement "A" to see if this product will work on your class I.



**FullBack™**  
PREMIUM TRUNK BIKE RACK



This fully loaded, sleekly styled trunk rack securely holds your bikes. It's simple to use, easy to install, folds flat for storage, and looks sweet on your car. SuperCush cradles with ZipStrips™ secure the bikes and allow for easy install.

2-BIKE #8002634  
3-BIKE #8002633



**HangOut™**  
TRUNK BIKE RACK



Super simple and built to last, the HangOut secures your bikes for a confident carry on just about any vehicle. Loading and unloading is a piece of cake, and when you aren't off adventuring, fold it flat for compact storage.

2-BIKE #8002637  
3-BIKE #8002638



**BIKE RACK ACCESSORIES**



**TRUNK RACK COMPARISON**

**Trunk Racks**

	Number of Bikes	Arms Fold Flat	Bottle Opener	Tool-Free Install	Anti-Sway Cradles	Locks to Vehicle	Locks Bikes to Rack
FullBack™ 2	2	✓	✓	✓	✓	✓	✓
FullBack™ 3	3	✓	✓	✓	✓	✓	✓
HangOut™ 2	2	✓		✓	✓		
HangOut™ 3	3	✓		✓	✓		



**TubeTop™**

Creates a temporary top-tube on unique bike frames such as kids' and women-specific bikes. Allows the bike to sit securely on a tilt- or swing-style hitch rack.  
#8002531

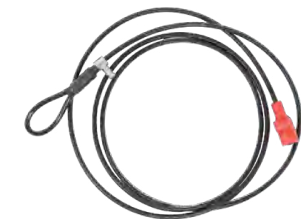

**9' SKS Locking Cable**

Extra-long cable so you can keep all your bikes in one place. Add 1 SKS Lock.  
#8007233



**HitchLock™**

Locks any non-locking hitch rack to your receiver.  
#8007235



**PlateMate**

License plate mount for bike racks, for plate visibility.  
#8002713





## HighSpeed™ PREMIUM ROOFTOP FORK BIKE MOUNT

Streamlined and strong, our most advanced fork mount securely handles all types of bikes and axles. Its integrated TorqueRight™ knob tightens with no worries, and the forward shift and low profile offer excellent hatch clearance. Integrated locking features require lock cores sold separately. T-slot compatible.

#8002115

Add 4 SKS Locks #8007204

Add SmarT-slot 1 for T-slot mounting #8002122



Easily clamps onto thru axle safely and securely.



Built in TailWhip™ retractable locking cable (add SKS Locks).



Integrated TorqueRight™ knob tightens axle in place.



Securely carries bikes with up to 5" wide tires\*.



Fits QR 9mm and thru-axles 12 mm, 15x100/110, 20 mm

\*FatBike QR Locking Skewer required for fat bikes with dropout forks



## ForkLift™ ROOFTOP FORK BIKE MOUNT

The ForkLift secures your bike without touching any of the painted surfaces. Quick to load and easy to install, it's ready to go right out of the box—it's a great choice for spur-of-the-moment rides. Just pop it on, load your bike, and go.

#8002098

Add 2 SKS Locks #8007202

Thru Axle Adapters

12mm X 100 #8002116

15mm X 100 #8002099

15mm X 110 #8002113

20mm X 110 #8002096



Fits 20" to 29" wheels and tires up to 3"



## HighRoad™ PREMIUM ROOFTOP UPRIGHT BIKE MOUNT

Our most noble upright bike mount, the HighRoad is aerodynamic, secure, easy to load, and fits almost any bike without touching the frame. The adjustment-free hoop with its torque-limiting tensioner requires no wheel removal. Integrated locking features require lock cores sold separately. (T-slot compatible)

#8002114

Add 2 SKS Locks #8007202

Add SmarT-slot 1 for T-slot mounting #8002122



Built in TailWhip™ retractable locking cable (Add SKS Locks).



Integrated TorqueRight™ knob tightens wheel hoop.



Streamlined bar-hugging design and excellent rear-hatch clearance.



Folds to a stowed, flat position when not in use.



Hoop accommodates 26" to 29" wheel sizes and 23mm to 4" tire widths.



## FrontLoader™ ROOFTOP UPRIGHT BIKE MOUNT

Super-easy to load, totally secure, and a proven customer favorite, the FrontLoader carries your complete bike—no wheel removal needed. The universal mounting system fits just about any crossbar out there, and install is easy—no tools or assembly needed.

#8002103

Add 2 SKS Locks #8007202



Easy-to-use spinning knob tightens the wheel down.



Quick-adjust wheel hoop secures a variety of tire sizes.



Fits 20" to 29" wheels and tires up to 3"



Folding wheel hoop minimizes drag and wind noise.



Easy-to-adjust sliding wheel tray fits a wide range of bike lengths.





## ROOF MOUNT COMPARISON

	Mount Type	Number of Bikes	Locks to Vehicle ★	Folds Flat	Tool-Free Install	Locks Bikes ★	Fat Bikes	Fits most Racks	Weight lbs.
HighSpeed™	Fork	1	✓	N/A	✓	✓	✓	✓	16
HighRoad™	Wheel	1	✓	✓	✓	✓	✓	✓	24
ForkLift™	Fork	1	✓	N/A	✓	✓		✓	7
FrontLoader™	Wheel	1	✓	✓	✓	✓		✓	13



**Thru-Axle Fork Adapters**  
Allows you to put thru-axle bikes onto fork-mount bike racks, like the ForkLift.

- 12MM X 100 #8002116
- 15MM X 100 #8002099
- 15MM X 110 #8002113
- 20MM X 110 #8002096



**ThruAxle Skewer**  
Works with WheelHouse to hold wheels with 15 or 12mm thru-axes.  
#8002110



**Smart-slot Kit 1**  
Creates T-slot mount for HighSpeed and HighRoad.  
#8002122



**QR Locking Skewer**  
Locking QR skewer that fits any fork-style bike mount.  
Fat Bike #8002120  
Universal #8002118



**WheelHouse™**  
Stow your front wheel on the roof alongside your bike.  
#8002108





## GateKeeper™ TRUCK BED TAILGATE PAD



Durable exterior protects your bike from your truck's tailgate while the soft felt backing protects your truck's paint. Integrated SitTight™ bike cradles and G-hook buckles add extra stability and protection for your bikes and the HindSight™ tuck-away cover opens up the view for your back-up camera.

- Medium Black -#8007455
- Medium Cascade Blue -#8007459
- Large Black -#8007456
- Large Cascade Blue -#8007460



G-Hook tension lock system is easy on carbon bike frames and painted surfaces.



Add your own bike lock to the built-in cable lock loop to secure your bikes.



Transports up to 5 bikes-Medium.  
Transports up to 6 bikes -Large.



HindSight™ cover allows use of your backup camera.

LEARN MORE AT [YAKIMA.COM](http://YAKIMA.COM)



# TRUCK

**YAKIMA**  
TAKE IT EASY.

## BORN WHERE THE ASPHALT ENDS

### THE NEW YAKIMA OFF-ROAD RATING

Yakima Off-Road Rated is a breakthrough testing standard that's making its debut in our HD Truck Collection. Redefining what it means to handle rough terrain on the regular, this new standard surpasses the international ISO requirements in many areas. We vigorously test for unmatched endurance using controlled worst-case-scenario lab simulations as well as real-world driving. Every outing puts qualified equipment through the off-road wringer with evasive maneuvers, swerving, speed bumps, and emergency stops. Needless to say, all Off-Road Rated products are specifically designed to take bonafide beatings off the beaten path—where the underbrush grows and the wild ones roam.



## HOW TO BUILD YOUR TRUCK RACK

1

### SELECT THE RACK THAT IS RIGHT FOR YOUR LIFESTYLE

OverHaul™ HD - Adjustable height, 19-30", heavy-duty, over the bed rack  
OutPost™ HD - Fixed height at 13", heavy-duty, over the bed rack  
BedRock™ HD - Fixed height flush with bed rails, heavy-duty, adjustable  
*(See other available options on pg. 8)*

2

### CHOOSE YOUR CROSSBAR LENGTH

HD Bars are sold separately for the perfect fit on your truck. They come in 4 lengths, SM (55"), MD (60"), LG (68"), XL (78"). Visit [Yakima.com](http://Yakima.com) and "Add Your Vehicle" to rely on us for the length. Or, choose which will work best for you.

3

### INSTALL AND GO!

It's really that easy. Once you've installed the rack that's right for you, add the gear mounts for all of your adventures.





## OverHaul™ HD

### ADJUSTABLE-HEIGHT HEAVY-DUTY TRUCK BED RACK

For weekend adventures and hardworking weekdays, the Overhaul HD adjustable truck rack offers best-in-class payload and unmatched versatility. Leveraging our new HD Bars for a 500-lb. on-road carrying capacity, and paired with Yakima's 300-lb. Off-Road Rating, the OverHaul HD truck rack is the ideal foundation for heavy loads. The crossbar height can be adjusted to suit your needs: way up, for long loads to go over the cab—or down low, to get the rack out of the wind. The uprights are easy to take on and off in minutes, so the truck's only racked-up when needed. The OverHaul HD truck rack uses any of our HD Crossbar sizes, and accepts our SideBars™ for attaching off-road and utility accessories. Multiple tie-down points and the ability to fit most truck beds—including select tonneau covers—make this an ultra-functional rack that works and plays as hard as you do.

• **Yakima HD Bar crossbar sold separately for a custom fit**

- Designed and tested for all common truck beds using our BedGrip™ clamp design, including tracked beds and select tonneau covers
- Built to last with engineered aluminum construction and a durable powder-coat finish
- Compatible with all Yakima mounts to carry kayaks, surfboards, bikes, rooftop tents, lumber, and more
- Integrated SKS (Same Key System) locks to secure your rack system to the truck bed
- Built in bottle opener—cheers!

#8001151



Integrated tie-down points help easily secure any load.



Easily adjustable height from 19–30".



Easy on-off placement in minutes with our patent-pending QuickChange™ rack attachment.



Yakima HD Bar crossbar sold separately - 60"/68"/78" lengths.

LEARN MORE AT [YAKIMA.COM](http://YAKIMA.COM)



## OutPost™ HD

### MID-HEIGHT TRUCK BED RACK

Built to handle heavy loads on backcountry terrain, the OutPost HD truck rack is ready for rugged overland adventures. The mid-height design provides a low center of gravity, easy accessibility to gear, and the perfect platform for the SkyRise™ Rooftop Tent. Leveraging our new HD Bars for a 500-lb. on-road carrying capacity, and paired with Yakima's 300-lb. Off-Road Rating, the OutPost HD truck rack is a firmly engineered foundation for a fully loaded overland rack system. Pair the OutPost HD truck rack with the HD Bar length that best fits your bed and gear. Add our SideBar™, mounts, and accessories, and you're set to explore the backcountry with confidence.

• **Yakima HD Bar crossbar sold separately for a custom fit**

- Designed and tested for all common truck beds using our BedGrip™ clamp design, including tracked beds and select tonneau covers
- Built to last, with engineered aluminum construction and durable powder-coat finish
- Compatible with all Yakima mounts to carry kayaks, surfboards, bikes, rooftop tents, and more
- Integrated SKS (Same Key System) locks your rack system to the truck bed

#8001152



Integrated tie-down points help easily secure any load.



Fixed mid-height position of 13" provides easy gear access and a low center of gravity.



Easy on-off placement in minutes with our patent-pending QuickChange™ rack attachment.



Yakima HD Bar crossbar sold separately - 60"/68"/78" lengths.

CURRENT PRICING AVAILABLE AT [YAKIMA.COM](http://YAKIMA.COM)



# BedRock™ HD

## LOW-PROFILE HEAVY-DUTY TRUCK BED RACK

Sleek and strong, the BedRock HD's low profile delivers a 300-lb. on-road capacity and Yakima's exclusive new Off-Road Rating for up to 180 lbs.—all without the need to drill into the truck bed. Pair it with the HD Bar length that best fits the bed to carry bikes, skis, cargo boxes, or the SkyRise™ Rooftop Tent—all while preserving valuable cooler-carrying capacity underneath. This powerhouse truck rack provides strength and security, easily accessible tie-down points, and T-slot attachment capability that makes adding gear easy.

- **Yakima HD Bar crossbar sold separately for a custom fit**  
68"/78" lengths
- Built to last, with engineered aluminum construction and durable powder-coat finish
- Designed and tested for all common truck beds
- Integrated SKS (Same Key System) locks the rack system to the truck bed
- Built-in bottle opener—cheers!

#8001160



# TRUCK RACK ACCESSORIES

## STAY ORGANIZED AND EFFICIENT

Outfit your rig in the accessories and mounts that you need for your backroad roundups. Have the confidence to barrel down that gravel road, outside of cell service, knowing good and well that your rig is decked to the nines in survival mode.



**LoadStop™**  
Heavy-duty load stops with integrated tie-down point.  
SET OF 4 #8001161



**HD Hook Straps**  
Heavy-duty, steel, cargo tie-down straps with retention latch.  
SET OF 2 #8001165



**Ladder Roller**  
24" wide T-slot mounted load assist roller.  
#8001163



**Recovery Track Mount**  
Heavy-duty mount for recovery tracks.  
#8001164



**Rotopax Mounting Kit**  
T-slot mounting bracket for Rotopax™ PACK mounts.  
#8001167



**TopGrip™**  
T-slot mounted gear holder. Best for paddles, shovels, and axes.  
#8004086



T-slot attachments make adding gear mounts and accessories fast and easy.



Easy-to-reach low-profile height position makes it easy to rack out and reach gear.



Simple, tool-free attachment makes installation, removal, and crossbar spread adjustments a breeze.



Yakima HD Bar crossbar sold separately



**WearStrips™**  
Extra-thick rubber infill for Yakima HD bars.  
SET OF 2 #8001166



**EyeBolts™**  
Heavy-duty T-slot tie down points.  
SET OF 2 #8001162







## HD Bar HEAVY-DUTY CROSSBAR

Our burliest crossbar ever, the HD Bar is the one for heavy loads, rugged terrain, and maximum utility. It delivers the muscle our new truck racks demand, and works with our StreamLine towers to get the heavy-duty job done right. The engineered aluminum construction provides superior support without weighing things down, integrated tie-down points to simplify load security, and T-slot attachment technology for adding gear mounts the fast, easy way. The Yakima Way.

**Required for Yakima OverHaul HD, OutPost HD, and BedRock HD**

- SM (55") | #8001156
- MD (60") | #8001157
- LG (68") | #8001158
- XL (78") | #8001159



Integrated tie-down points on end caps make it easy to secure gear.



T-slots on the top and bottom to easily add Yakima and compatible gear mounts.



Includes rubber infill for top T-slot for load protection and wind noise reduction.



Compatible with all StreamLine towers with our new HD Bar SL Adapter. (sold separately #8003541)



## BedTrack™ Kit 1 ADAPTER KIT FOR TOYOTA AND NISSAN BED TRACKS

Adapts our OverHaul HD™ and OutPost HD™ truck rack systems to work seamlessly with Toyota and Nissan factory utility tracks.

#8001168



## Tonneau Kit 1 ADAPTER KIT FOR SELECT TONNEAU COVERS

Adapts Yakima's OverHaul HD™ and OutPost HD™ truck rack systems to work with the integrated tracks on Retrax XR Series, Embark LS and Pace-Edwards UltraGroove tonneau covers.

#8001155





## BedTrack™ Kit 2

### HD TRACKS

This simple kit easily adapts our OverHaul HD™ and OutPost HD™ truck rack systems to Yakima HD Tracks without sacrificing the racks 500lb capacity.

#8001172



## HD Track

### CUSTOM INSTALL TRACKS

Mounts to truck beds and other applications allowing the use of OverHaul HD, OutPost HD and SkyLine Towers with LP26 to be mounted to.

72" #8001633  
60" #8001632  
54" #8001631



## DiamondBack Base Track

### CUSTOM INSTALL TRACKS

This HD Track kit that allows you to mount a SkyLine™ tower, OverHaul™ HD or OutPost™ HD system to your Diamondback truck cover while giving you access to open both front and rear panels on your cover.

#8001634



## SideBar™

### SIDE RAILS FOR OVERHAUL HD AND OUTPOST HD

The SideBar heavy-duty side rails increase the utility of our OverHaul HD™ and OutPost HD™ truck rack systems with more carrying space. Available in two size options and a telescoping design, it's always a perfect fit. The full-length T-slot and 100-lb. capacity make it easy to attach more accessories and gear. Now you can customize your Yakima truck rack system to securely handle a wider range of outdoor fun.

SHORT BED, SET OF 2 #8001153  
LONG BED, SET OF 2 #8001154



Engineered aluminum construction delivers serious strength.



Holds up to 100 lbs. of gear and accessories.



## TRUCK BED RAIL FORK MOUNT BIKE RACKS



**Locking BedHead™**  
1 BIKE  
BedHead with included locking skewer.  
#8001133



**BlockHead™**  
1 BIKE  
A permanent bike-mounting solution for your truck bed or anywhere you bolt it.  
#8001117



**Locking BlockHead™**  
1 BIKE  
BlockHead with included locking skewer.  
#8001118



# TRUCK BED EXTENDER

GET A LITTLE MORE USE OUT OF THE BED



## LongArm™ TRUCK BED EXTENDER

A much easier way to load and carry fishing kayaks, big SUPs, canoes, lumber, and more, the LongArm extends your truck's bed by a whopping four feet. Easy to use, it adjusts to four carrying positions and can haul up to 300 lbs.\* The LongArm takes your truck bed to the next level.

#8001149



Multiple adjustment points for long loads at various heights.



Integrated tie-down point plus bottle opener.



- 60-inch wide crossbar with integrated tie-down points
- Weighs just 12 lbs., carries up to 300 lbs. (\*165 at tallest setting)
- Also great for ladders and lumber



**LongArm Pad**  
Adds a padded layer of protection.  
#8007417



**LongArm Height Extension**  
Utilize the extension to perch your long loads over the truck cab. 165 lb. max load with extension.  
#8001150



CARGO

**YAKIMA**  
TAKE IT EASY.





## CARGO BOX COMPARISON

	Interior Space (Cu <sup>ft</sup> )	Locks To Vehicle	Locks Gear Inside	Extra-Stiff Lid	Automotive Styling	Gear for People	Ski Length Max.	Dual Side Opening	Dimensions (LxWxH)	Weight (Lbs.)
CBX™ SOLAR	16	✓	✓	✓	✓	3	185	✓	83" X 38" X 15"	60
CBX™ 18	18	✓	✓	✓	✓	4	215	✓	91" X 38" X 17"	65
CBX™ 16	16	✓	✓	✓	✓	3	185	✓	83" X 38" X 15"	60
GrandTour™ 18	18	✓	✓	✓	✓	4	215	✓	91" X 37" X 17"	65
GrandTour™ 16	16	✓	✓	✓	✓	3	185	✓	79" X 35" X 18"	51.5
SkyBox™ 21	21	✓	✓	✓		5	215	✓	92" x 36" x 18"	62
SkyBox™ 18	18	✓	✓	✓		4	215	✓	92" x 36" x 16"	52
SkyBox™ 16	16	✓	✓	✓		3	185	✓	81" x 36" x 15"	47
SkyBox™ 12	12	✓	✓	✓		2	215	✓	92" x 24" x 16"	41
RocketBox™ Pro 14	14	✓	✓			3	170	✓	74" x 33" x 16"	38



## DeepSpace™ 10

### 10 CUBIC FT. CARGO BOX

Built to maximize your cargo carrying capacity while accommodating whatever gear you throw at it. The universal mounting hardware make it perfect to nest behind your truck cab or mount it on your vehicle's roof and the wide-angle opening means hassle-free loading and unloading of everything from camping gear to tools. Load it up, lock it up and go.

#8001179

## SKI & SNOWBOARD LENGTH COMPARISON

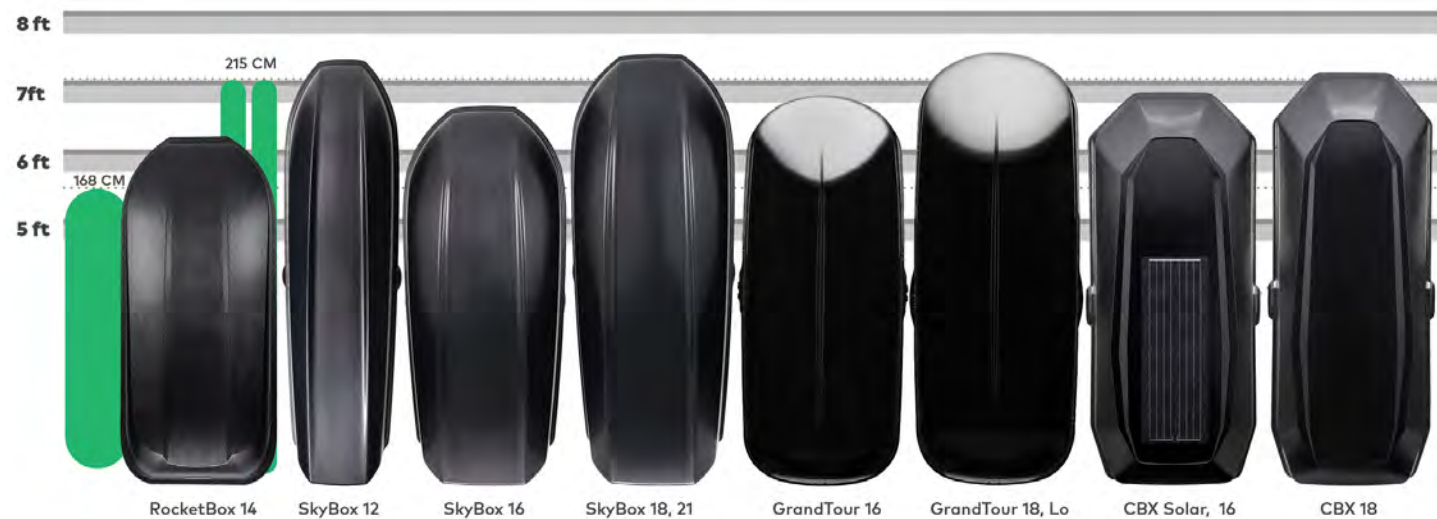

## CARGO BASKET WEIGHTS

BASKET	Weight Lbs.	BASKET	Weight Lbs.	BASKET	Weight Lbs.
SkinnyWarrior	23	MegaWarrior	45	OffGrid LG	49.9
SkinnyWarrior + Extension	27.6	MegaWarrior + Extension	61	OffGrid LG + Extension	67.5
LoadWarrior	33	OffGrid MD	38		
LoadWarrior + Extension	48	OffGrid MD + Extension	51		



Requires a set of bed mounted crossbars or top of vehicle crossbars.



10 Cubic Feet of Storage Space.



SKS lock included.



Wide-angle opening makes placing or finding your gear easy.





## CBX™ SOLAR

### PREMIUM SOLAR CARGO BOX

Sun's out, power's on. The CBX Solar blends clean-lined, modern aesthetics with a first-of-its-kind integrated solar panel. We teamed up with Sunflare to create a solar panel capable of delivering a 36W/5-volt output for when you're adventuring off the grid. With 2 USB ports, it provides enough juice for a small campsite, won't drain power from your vehicle and can charge phones, tablets, camping lanterns and action cameras. An integrated, easy-grab lid handle locks gear inside, and the removable torque tool stows away to free up all 16 cubic feet of available space for your gear.



**CBX SOLAR**  
#8007388



Integrated solar panel is heavy duty to withstand the elements.



Interior converter features two USB ports for charging devices.



Dual-sided opening for easy access on either side of your vehicle.



Removable torque knob ensures a secure installation.



## CBX™

### PREMIUM CARGO BOX

Form, meet function. A carrying option worthy of your vehicle's roof, the CBX combines rugged, trail-ready, aesthetics and an all-new textured surface to raise the cargo box game. The details make the design, with an integrated, easy-grab lid handle that locks gear inside, a removable torque tool that stows away to deliver all available space for your gear, and premium black chrome badging that stands out from the crowd.



**CBX 16**  
#8007387



**CBX 18**  
#8007389



Flattened interior provides more usable space for the gear you need.



Full metal intuitive opening handle locks gear inside the box and the box to the vehicle.



Dual-sided opening for easy access on either side of your vehicle.



Removable torque knob ensures a secure installation.





## SkyBox CARGO BOX

The legend. Combining aerodynamic performance and road-proven durability, the best-selling SkyBox is the perfect choice for families and roadtripping adventurers. Four sizes mean there's definitely one that fits your needs.



## GrandTour™ PREMIUM HIGH GLOSS CARGO BOX

For those who like to travel in style, the GrandTour elevates cargo box design with a premium, sleek look that doesn't sacrifice superior functionality or exceptional capacity. It performs just like Yakima's trusted SkyBox series, but with technical upgrades and an automotive sheen that looks great on your vehicle. It also offers best-in-class features. Upgraded installation with easy to use Torque knob allows for flattened interior for maximum usable space. Beautiful design and premium features make the GrandTour a sleek and adaptable addition to your vehicle.



**GrandTour 16**  
#8007394



**GrandTour Lo**  
#8007398



**GrandTour 18**  
#8007395



Removable torque knob ensures a secure installation.



Metal, SuperLatch™ handle is easy-to-use and locks gear inside.



Dual-sided opening for easy access on either side of your vehicle.



Flattened interior provides more usable space for the gear you need.



**SkyBox 12**  
Slim but mighty storage leaves room for other mounts on your rack.  
#8007334



**SkyBox 18**  
Family-sized adventures.  
#8007336



**SkyBox 16**  
Serious year-round use.  
#8007335



**SkyBox 21**  
The Big Kahuna.  
#8007337

### FEATURES



SuperLatch™ security with SKS locks ensures your box is secure.



Easy to mount and remove—no tools or assembly required.



Dual-sided opening for easy access on either side of your vehicle.

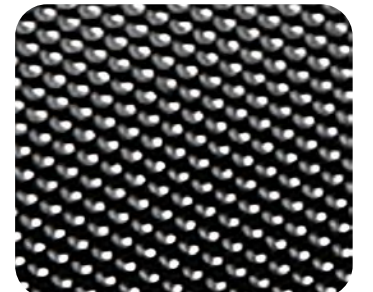

Aerodynamic, textured carbonite lid reduces drag and wind noise.





# RocketBox Pro

CLASSIC DESIGN, PRO-LEVEL PERFORMANCE

The RocketBox is versatile yet budget-friendly.

**RocketBox Pro 14**  
#8007192



Dual-sided opening for easy access on either side of your vehicle.



Simple push-button access.

## CARGO BOX HATCH CLEARANCE TIPS

To find the best fit for your cargo box, use the measurement in figure 2 to find the necessary distance for your product. The measurements may require you to adjust your crossbars. Do NOT adjust BaseLine Tower Systems.

**Adjustable Roof Rack Systems:** TimberLine Towers, SkyLine Towers\* with Tracks, RidgeLine Towers\*, OverHaul HD, OutPost HD, BedRock HD, BedRock, Outdoorsman, and most Factory Roof Racks.

\*Some vehicles have a fixed crossbar spread, check yakimatech.com for your vehicle's crossbar capabilities in the measurements section.

### Measure Distance

From the front crossbar, measure from the center of that crossbar to the edge of the open trunk hatch. Make sure that you are measuring across the flat surface of the crossbars.

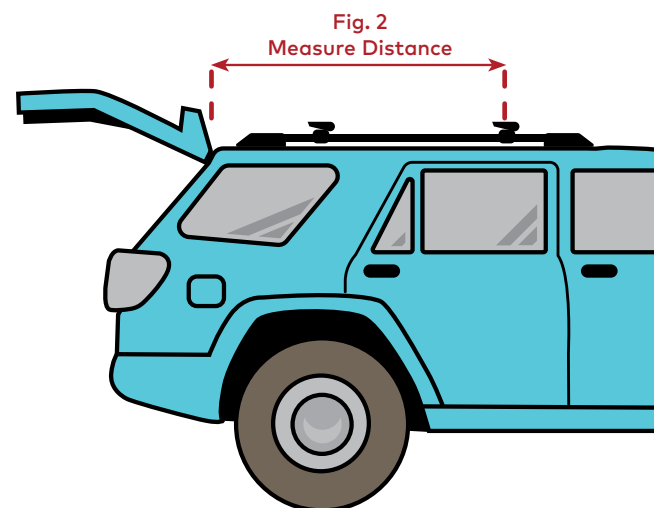

Product	Minimum Distance	
CBX SOLAR, 16	45"	113 cm
CBX 18	52.25"	132.7 cm
GrandTour 16	48"	114.3 cm
GrandTour 18, Lo	50.75"	137.16 cm
SkyBox 16	47"	132.08 cm
SkyBox 12, 18, and 21	57"	144.78 cm
RocketBox 14	45"	114.3 cm

LEARN MORE AT YAKIMA.COM



# OffGrid

PREMIUM CARGO BASKET

The OffGrid delivers proven Yakima performance with all-new features and an advanced aerodynamic design. Add some gear mounts and carry bikes, boats, skis, and more gear. This premium cargo basket works hard, hauls a ton, handles years of rugged adventure, and looks awesome on your roof.



**OffGrid Medium**  
#8007138



**OffGrid Large**  
#8007139



Weather-resistant, heavy-duty steel construction.



Fully adjustable accessory bars help secure loads.



**Accessory Bar**  
Creates extra attachment point for gear mounts or a load stop.  
OffGrid MD #8007353  
OffGrid LG #8007354



Simple-to-use BandClamp mounts secure basket quickly.



Included fairing reduces drag and wind noise.

CURRENT PRICING AVAILABLE AT YAKIMA.COM

## OFFGRID ACCESSORIES



**Extensions**  
Load more gear with 40% more space in your OffGrid.  
OffGrid MD #8007108  
OffGrid LG #8007109



**Spare Tire Carrier**  
Mount bulky spares up to your basket and make room inside your vehicle for more toys.  
#8007076



**Cargo Nets**  
Keep loose gear safe and secure inside the cargo basket.  
OffGrid MD #8007072  
OffGrid LG #8007081



**Smart-slot Kit 3**  
Low-profile conversion kit to mount OffGrid into JetStream crossbars' T-slot.  
#8007356



**SKS Lock Cores**  
OffGrid accepts 4 SKS lock cores to secure the basket to your roof rack.  
4 PACK #8007204





## Warrior Series

### CARGO BASKETS

No matter what gear your friends show up at your driveway with, you'll be ready with any of the Warrior baskets. From firewood and bins, to luggage, double basses and furniture, you're ready to load up. Installation is quick and easy, and universal mounts fit virtually any crossbar.



**MegaWarrior™**  
#8007080



**SkinnyWarrior™**  
#8007014



**LoadWarrior™**  
#8007070



## WARRIOR SERIES ACCESSORIES



### Stretch Nets

Keep loose gear safe and secure inside the cargo basket.

SkinnyWarrior #8007018  
MegaWarrior & Offgrid MD #8007072  
LoadWarrior & Offgrid LG #8007081

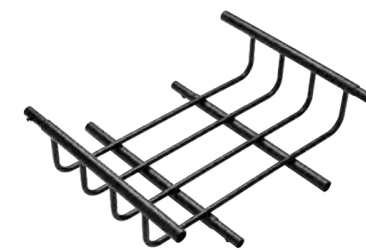

### SkinnyWarrior Extension

Add 16" to the overall length to the SkinnyWarrior basket.

#8007016



### LoadWarrior Extension

Expand your LoadWarrior's cargo capacity by 40%. That's a lot. Adds 18" to your LoadWarrior.

#8007074



### MegaWarrior Extension

Expand your MegaWarrior's cargo capacity by 40%. That's a lot. Adds 22" to your MegaWarrior.

#8007082



### Axe Shovel Bracket

Secures a single axe or shovel to a Warrior cargo basket.

#8007078



### Hi-Lift Jack Carrier

Keep your greasy, dirty Hi-Lift Jack outside of your basket and away from your gear.

#8007077



### Spare Tire Carrier

Mount bulky spares up to your basket and make room inside your vehicle for more toys.

#8007076



### Locking Brackets

Make sure your cargo basket doesn't go anywhere by locking it to your roof rack.

SET OF 2 #8007064



### Light Mounting Bracket

Heavy-duty steel bracket accommodates lights of virtually any shape or size.

SET OF 2 #8007075



## CARGO BASKET COMPARISON

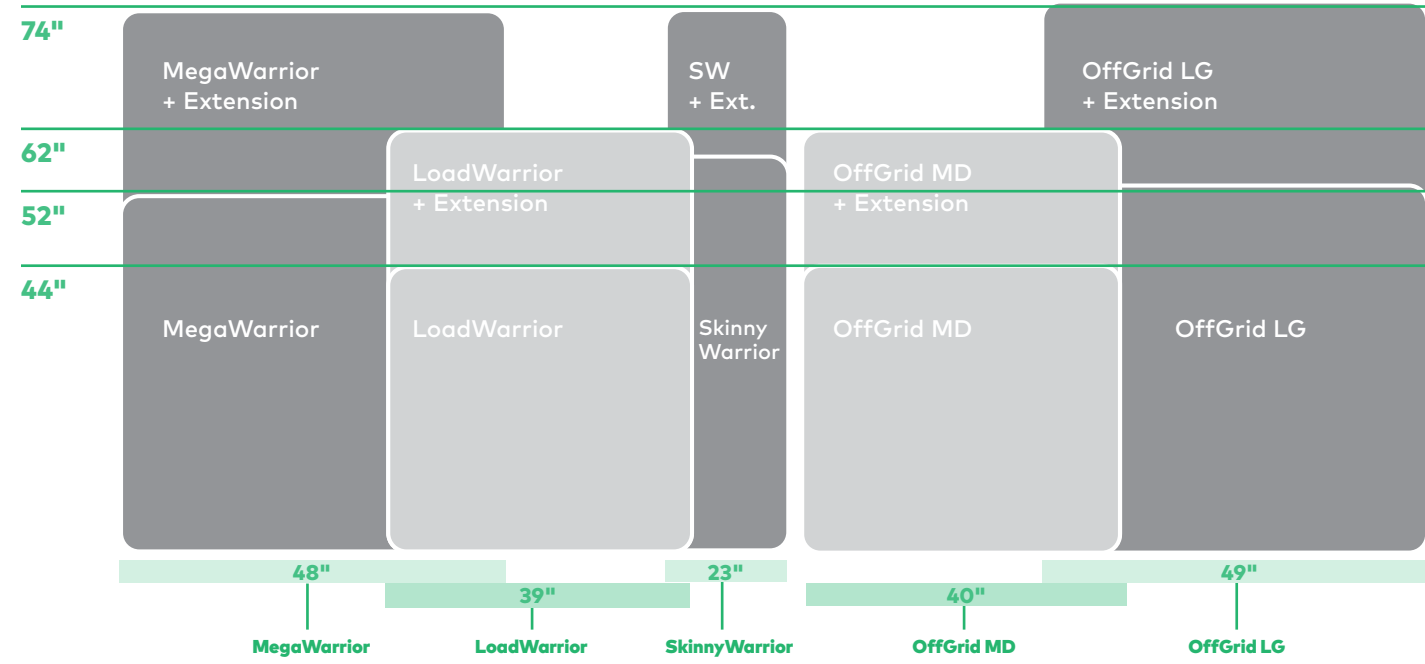

**WATER**





## BOAT MOUNT COMPARISON

	Mount Style	Number of Boats	Locks to Vehicle *	Folds Flat	Tool-Free Install	Fully Assembled	Tie-Downs Included	Weight Limit (Lbs.)
BigCatch	Saddle	1	✓		✓	✓	✓	150
EvenKeel	Saddle	1	✓		✓	✓	✓	80
DeckHand	Saddle	½ ◆	✓		✓	✓	✓	80
SweetRoll	Saddle + Roller	1	✓		✓	✓	✓	80
HandRoll	Roller	½ ◆	✓		✓	✓	✓	80
JayLow	J-Cradle	2 *	✓	✓	✓	✓	✓	80 / 110
JayHook	J-Cradle	1			✓	✓	✓	80
BigStack	Stacker	4 *	✓	✓	✓	✓	✓	Dependent on vehicle roof limit

◆ DeckHand and HandRoll should be paired together to create one kayak mount(require 2 sets or mixed pair).  
 \* Carrying 2 boats with JayLow / 4 with BigStack, requires the mount to be in stacker position, and additional tie-downs are needed.

## PRODUCT WEIGHTS

WATER MOUNT	Weight Lbs.
BigCatch	8.5
JayLow	11.5
SweetRoll	7.7
ShowBoat 66	18.2
BigStack	7
EvenKeel	5
SUPDawg	14
DeckHand	4
HandRoll	5
JayHook	11
ShowDown	22
BoatLoader EVO	3.8
TopGrip	1
RipCord	2

# WATER CRAFT CARRYING OPTIONS

## BOATS OR BOARDS, WE HAVE AN EASY SOLUTION

There are multiple ways to carry different types of boats and boards. Here is a quick break down of your available options:



**WHAT:** Kayak  
**STYLE:** J-cradle  
**HOW:** Load the boat on it's side.  
**BENEFIT:** Leaves space on the roof rack for other gear mounts.



**WHAT:** Kayak  
**STYLE:** Saddle  
**HOW:** Load the boat as it would sit on water.  
**BENEFIT:** Easier to load heavier boats this way, no need to turn it on it's side.



**WHAT:** Kayaks and Surf/SUP  
**STYLE:** Load Assistance  
**HOW:** Load boat or SUPs at waist height.  
**BENEFIT:** No need for multiple people to load the craft onto the vehicle roof.



**WHAT:** Canoe  
**STYLE:** Bracket  
**HOW:** Load the boat upside down.  
**BENEFIT:** Low-profile mount and the only canoe option.

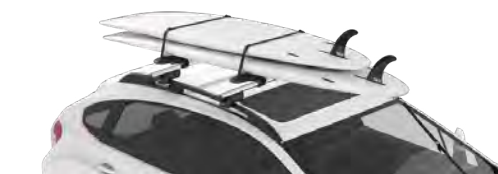

**WHAT:** Surf / SUP  
**STYLE:** Flat Mount  
**HOW:** Load the boards upside down.  
**BENEFIT:** Bring multiple boards, as well as long boards, that you don't have to shove into the trunk.





150 lb. weight capacity.  
That's a big bass boat!



## BigCatch™

### KAYAK FISHING BOAT SADDLES

Bust out the big boats with the BigCatch's whopping 150-lb. capacity. Introducing the first universal kayak saddle built to handle heavy fishing kayaks and sit-on-tops. The rubber-padded saddles conform to the kayak's hull for a super-secure, full-contact carry that's easy on your boat. A simple, tool-free install will load it up faster for even more time to chase the next big catch. If you have T-slot crossbars, don't forget our SmarT-Slot Kit 4 (sold separately) for an even cleaner, more integrated look.

SET OF 4 #8004091



Specially designed to support the extra weight of fishing and sit-on-top kayaks.



Oversized cradle protects the boat and conforms to a variety of hull shapes.



Universal mounting hardware fits our StreamLine, RoundBars, and HD Bars—along with most other crossbars.

### CROSSBAR ADAPTERS



**SmarT-Slot Kit 4**  
Turns BigCatch into a T-slot-capable boat mount.

#8004092



**RoundBar Kit**  
Adapter kit for use with BigCatch on RoundBars.

#8004093



## SweetRoll™

### ROOFTOP KAYAK SADDLE & ROLLER MOUNT



Loading your boat has never been easier than this! Two front and two rear saddles with integrated rollers hold your boat in place. The spring-loaded base automatically adjusts to the boat when loading. Sold in a set of 4.

SET OF 4 #8004074

Add 4 SKS Locks #8007204



Built-in rollers help glide the boat into place.

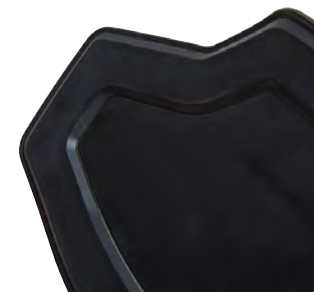

Rubber saddles protect the hull of the boat.



Pivoting saddle conforms to the shape of the boat.



Add Felt Pads for more protection. (Sold separately | #8004080)



## EvenKeel™

### ROOFTOP KAYAK SADDLES



Versatile. Thrifty. Secure. The EvenKeel provides best-in-class value for carrying your boat.

SET OF 4 #8004052







**DeckHand™**  
PREMIUM ROOFTOP KAYAK SADDLES



Designed for quick and easy loading, and featuring universal mounting hardware that works with just about every crossbar, the versatile DeckHand's padded, flexible cradles conform to your boat's shape for a secure carry.

SET OF 2 #8004083

Add 2 SKS Locks #8007202



Pair with HandRoll for a complete rooftop kayak system.



**HandRoll™**  
PREMIUM ROOFTOP KAYAK ROLLERS



An easy way to load and securely carry your boats, the HandRoll is perfect for any kind of kayak. Durable rollers guide your boat into place, and the universal mounting hardware works with almost any roof rack.

SET OF 2 #8004082

Add 2 SKS Locks #8007202



Pair with DeckHand for a complete rooftop kayak system.



**JayLow™**  
J-CRADLE ROOFTOP KAYAK MOUNT



Versatile, adaptable, and super low-maintenance, the JayLow kayak mount provides maximum loading and minimal fuss. No tools necessary for install with the easy-to-use SpinVice clamp. Carry one kayak in cradle position, or two in stacker position.

#8004073

Add 2 SKS Locks #8007202



Integrated boat ramp for easy loading.



Easy-to-use lever makes adjusting the mount a breeze.



Folds down flat when not in use.



Carry 1 boat in cradle and 2 boats in stacker position.





## ShowDown™

### LOAD-ASSISTING KAYAK AND SUP MOUNT

This mount makes loading and unloading heavy boats and boards a breeze. It tilts down more than two feet from the roof rack, takes on up to 45% of the boat's weight, then helps gently raise it up to the top of the vehicle. Once loaded, it securely cradles your boat or boards for the ride. No tools necessary for install with the easy-to-use SpinVice clamp.

- 80-lb. boat and board capacity easily handles your big kayak or a couple of SUPs
- Weighing only 22 lbs., it doesn't eat up your roof's carrying capacity
- Lowers down a lengthy 26" from roof rack height
- Provides a generous 30-45% weight assistance (depending on boat width)
- Felt-covered cradles flex to conform to your hull for secure transport
- Folds down flat to reduce drag and wind noise when not in use
- All tie-down straps included so you're ready to load right out of the box

#8004081

Add 2 SKS Locks #8007202



## JayHook™

### J-CRADLE ROOFTOP KAYAK MOUNT



Strong and reliable, the JayHook is a simple, secure way to carry any kind of kayak. The design is easy to load and doesn't eat up your rack space.

#8004084



## BigStack™

### KAYAK STACKER



Go BigStack to go big! Mount up to 4 boats on your roof, or use the extra room for a multisport adventure. HullGuard padding keeps your boats safe.

#8004041

Add 2 SKS Locks #8007202



## SHOWDOWN INSTALLATION TIPS

- Pull your mirror in first
- Minimum required crossbar spread is 24"
- Maximum recommended crossbar spread is 42"
- Maximum boat width is 36" with SUP saddle
- Maximum boat width is 28" with standard saddle
- Maximum boat weight is 80 lbs
- Two SUPs maximum
- 2 ShowDowns max per vehicle (60" bars or longer required)
- Please check [yakima.com/fit](http://yakima.com/fit) for your vehicle's compatibility with ShowDown. Not compatible with Q Tower.

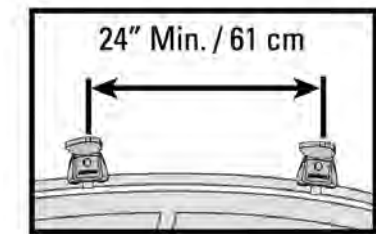

## FIT REQUIREMENTS

- A** • Distance from tower face to end of bar - 4" Minimum
- B** • Distance from tower face to inner face of outer ShowDown clamp - 4" Maximum
- C** • Distance from vehicle door to ShowDown in lowered position (unloaded) - 4" Minimum

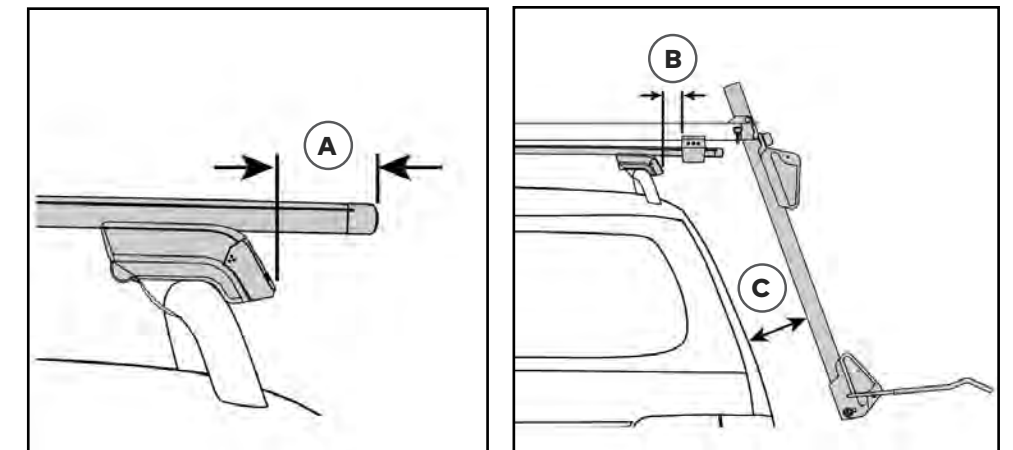





## ShowBoat™ 66

### LOAD ASSISTANCE

This ingenious load-assist roller slides out over the rear of the vehicle for easy access and vehicle protection while loading and unloading your boat.

- Padded to protect your kayak or canoe during loading and transport
- Works with a variety of kayak and canoe mounts
- Corrosion-resistant stainless steel and brass hardware

#8004068



## BoatLoader™ EVO

### LOAD ASSISTANCE

An easy way to make the load-up less of a chore, the BoatLoader EVO telescopes out 28" from your roof rack to help get canoes, kayaks, and boards up to the roof. When not in use, it stows neatly inside your RoundBar or CoreBar crossbar, ready and waiting for the next trip to the water. It's easier on your back, your boat, and your car's paint job.

#8004085



## KeelOver™

### ROOFTOP CANOE MOUNT



The KeelOver is a compact solution for a big canoe. It attaches directly to any roof rack for a quick, tool-free installation right out of the box.

SET OF 4 #8004069



LEARN MORE AT YAKIMA.COM



## SUPDawg™

### PREMIUM ROOFTOP SUP & SURFBOARD MOUNT

A stand-up paddle board mount that can hold up to two SUP Boards up to 36" wide. The SUPDawg is fully assembled out-of-the-box, features integrated rollers for easy loading, and includes SKS locks.

#8004075



Keeps your boards safe and sound with nylon-coated steel cables.



Locking, integrated strap storage keeps strap from flapping in the wind.



Easily install with locking SpinVice clamp.



Integrated rollers for easy loading.

CURRENT PRICING AVAILABLE AT YAKIMA.COM







**RipCord™**  
**LOCKING TIE-DOWN STRAP**  
**TO SECURE YOUR BOAT OR BOARDS**

Lock down surfboards, boats, bikes, and everything in between with these 12' locking cargo straps.

#8004048



# WATER CROSSBAR PADS

## ROOF RACK BOARD AND GEAR PROTECTION

Our anti-slip bar pads confidently carry SUPs, surfboards, or kayaks. Two designs—there's a perfect fit for just about any type of bar—and two widths let you choose the pad that fits your gear.



**Aero Crossbar Pads**

20" #8007412  
 30" #8007413



**RoundBar Crossbar Pads**

30" #8007415

## TEMPORARY ROOF RACK SOLUTION



Buckle attachment features a security clip to foil backseat pranksters.

**EasyTop™**  
**TEMPORARY ROOF RACK**

EasyTop carries up to 80 lbs. and has easy-to-use buckle attachments.

#8007418







## TopGrip™ ROOF RACK PADDLE HOLDER

Carry your paddle up top and out of the way. Secure and easy, smart and versatile, the TopGrip is a cushioned clamp that holds your paddle tight and installs in a breeze. Off the water? Use it to hang onto your shovel, axe, or Nimbus 2000.

#8004086

Add 2 SKS Locks #8007202

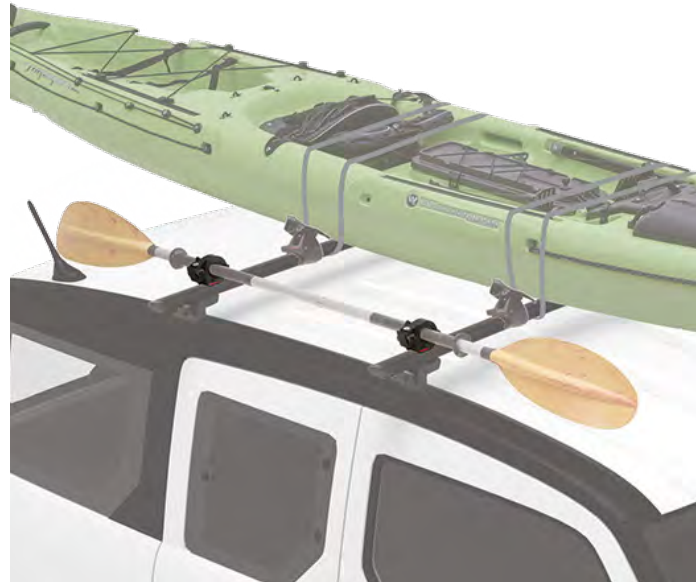

## BOAT / SURF ACCESSORIES



### Bow/Stern Tie-Down

Tie-downs feature ratcheting pulleys that are easy to use and corrosion-resistant.  
#8004031



### Boat Locker

10-foot cable secures your boat to your roof rack.  
#8007237



### SoftStrap™

Tie-down strap with padded covering for protecting surfaces and easy storage.  
SET OF 2 - 16 ft. #8007419



### Heavy-Duty Strap

Extra-strong tie-down strap with rubber covered buckle for protecting surfaces.  
SET OF 2 - 16 ft. #8005006



### Hood Anchor

An easy, drop-in solution for vehicles without a tie-down attachment point.  
SET OF 2 #8007416



# BASE CAMP



# SKYRISE BEST PRACTICES

There are loads of different adventure-mobiles out there and no matter what you drive, we want you to travel safe. We have assessed the SkyRise tents on many popular vehicles and designated them as "Certified" or "Not Certified." To find out if your vehicle is "Certified" for use with a Yakima SkyRise tent, [www.yakima.com](http://www.yakima.com)

If we have not yet assessed your vehicle, use the guidelines below to evaluate whether your vehicle and rack system may be used with a SkyRise tent.

## IMPORTANT

Use the list below to evaluate your own vehicle and rack for use with the a SkyRise tent. Any installation of a SkyRise tent to a vehicle and rack not listed as a Yakima Certified Fit is at the sole risk and responsibility of the owner / installer.

## VEHICLE EVALUATION GUIDELINES & BEST PRACTICES

- ✓ Vehicle AND roof rack system must have a minimum of 165 lb load-carrying capacity. Check your vehicle owner's manual to find your vehicle's maximum carrying capacity.
- ✓ Vehicle's crossbar spread (M4) must be between 26" and 40.5" when mounting the tent to open to the side of the vehicle, and must be between 26" and 34.5" when mounting the tent to open to the rear of the vehicle. **Fig. 3**
- ✓ The roof rack bars must have a minimum of 26" between the towers (M1 & M3). If not, there must be at least 3.75" of crossbar extending outside the tower, and do not position mounting hardware more than 1" away from the outside of the tower. **Fig. 3**
- ✓ The maximum distance from top of crossbar to ground: SkyRise Small = 86", SkyRise Medium = 98"
- ✗ CANNOT Be used with these Yakima Roof Rack Towers: BaseLine, Q-Tower, RailGrab Tower with Small Claw or Pin Adapter **Fig. 1**
- ✗ Do not use SkyRise with factory crossbars; they are too flexible.
- ✗ Do not use SkyRise if your vehicle's roof deforms or dents when heavy loads are applied.
- ✗ Do not install SkyRise on weak raised siderails of the "unsupported" type, as shown **Fig. 2**.
- ✗ Do not use SkyRise with any clamp-type or clip-style towers, unless specified by Yakima.
- ✗ Use of the SkyRise tent on other brands of roof racks is at your own risk. Please contact your roof rack manufacturer for their recommendation on carrying rooftop tents.

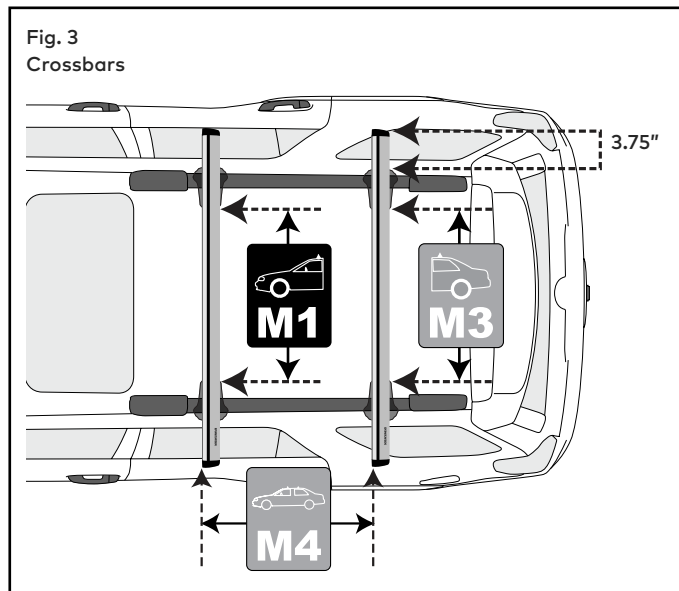
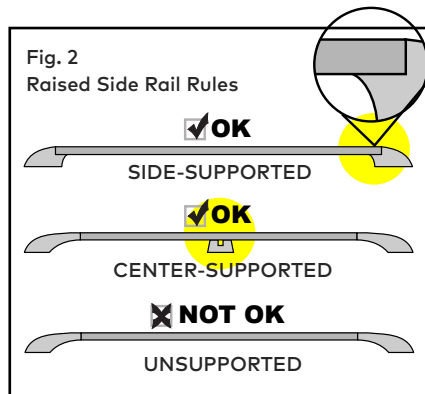
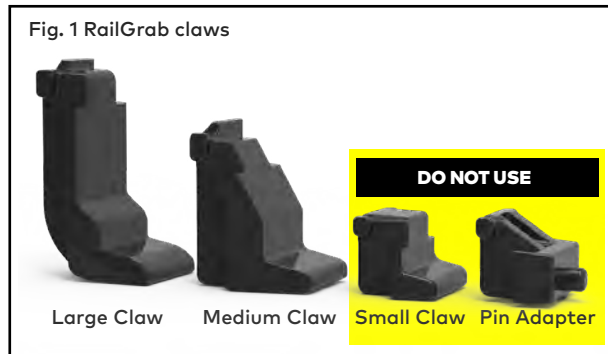

For vehicles with raised rails (see p. 16 to identify roof type), the crossbars must be positioned as close as possible to the side or center rail supports.

## OTHER INSTALLATIONS

**Truck Canopies / Topper / Shells / Truck Bed Covers** — Truck caps plus the SkyRise certainly make a great couple but like any relationship, it's at your own risk. Please contact your truck cap manufacturer for their recommendation and options for carrying rooftop tents on your truck cap.

**Non-Yakima Roof Racks** — At Yakima, your safety is our number one priority. While we highly respect all the players in the game, we cannot certify their roof racks. Please contact your roof rack manufacturer for their recommendation on carrying rooftop tents.

**Custom-Installed Roof Racks** — Custom installation can be a secure method to install a roof rack to your adventure-mobile. Due to the variety of applications, we cannot certify specific custom roof rack installations for the SkyRise tent. This includes custom-installed Landing Pads and tracks onto your vehicle's roof. Please contact the manufacturer of your vehicle for their recommendation and options for carrying rooftop tents.



## SkyRise™ HD HEAVY-DUTY 4 SEASON ROOFTOP TENT

This exciting addition to our SkyRise Family is your hub for the ultimate mobile base camp in any season. The extra-large windows and doors provide grand views and great ventilation—while the thick wall-to-wall foam sleeping pad provides cushy, all-night comfort.

SM 2-PERSON #8007436  
MD 3-PERSON #8007437

- **Tent Body** – 600D Ruggedized polyester fabric with a 3000MM waterproof PU coating
- **Rainfly** – 210D ripstop polyester, 3000MM PU waterproof coating
- Pre-set aluminum tent frame geometry offers more usable space
- Large doors, windows, and skylights open up the vistas
- Guy lines and D-rings on the tent floor to hang gear or tie down the tent in windy conditions
- Abrasion-resistant tent floor with textured finish for added durability
- Ladder has mid-height adjustment points for easy set-up, and auto-close function
- Tool-free attachment and lockable to crossbars, with SpinVice clamps—easy to put on, quick to take off
- Easy-to-deploy design means less work and more play—great when it's dark or raining
- 2.5"–thick foam mattress with removable cover



Feature	SMALL	MEDIUM
Capacity	2	3
Seasons	4	4
Load Capacity	400 lbs	600 lbs
Product Weight	100 lbs	120 lbs
Pitched	48" x 84" x 42" H	56" x 96" x 48" H
Collapsed	48" x 42" x 12" H	56" x 48" x 12" H
Security	Includes 2 SKS locks	





## SkyRise™

### ROOFTOP TENT ● COLOR

Camp wherever the road takes you with the SkyRise rooftop tent. The ultimate base camp shelter, it will expand your vistas, distance you from spiders and snakes, and—when the campsite's crowded—give you some penthouse-style privacy. It's packed with smart features like spacious interior, skylights, and a waterproof rainfly. Light, strong, and easy to set up, the SkyRise keeps you off the hard ground and puts you closer to the stars.

MD 3-PERSON #8007434

- 2.5"-thick built-in foam sleeping pad provides cushy comfort
- Sleeping pad includes removable cover for easy cleaning
- Guy lines and D-rings let you tie down the tent in high winds
- Abrasion-resistant tent floor is extra-durable
- 210D nylon tent body is strong and exceptionally lightweight
- Aluminum internal poles are light, strong, and pre-set to make pitching a breeze
- Tool-free attachment and lockable to crossbars, with SpinVice clamps—easy to put on, quick to take off
- 3-season weather protection

Feature	MEDIUM
Capacity	3
Seasons	3
Load Capacity	600 lbs
Product Weight	115 lbs
Pitched	56" x 96" x 48" H
Collapsed	56" x 48" x 12" H
Security	Includes 2 SKS locks



# BASE CAMP ACCESSORIES

STAY ORGANIZED AND EFFICIENT

## SKYRISE ROOFTOP TENT ACCESSORIES

Compatible with all Yakima tent models



### SideKick™

Shoe and gear bag that slides into tent-floor channel.  
#8007423



### SkyLoft™

Gear hammock for inside or below the SkyRise/HD.  
#8007424



### SkyHook™

Hanging carabiner gear hooks that slide into tent floor channel.  
SET OF 4 #8007425



### Gray BedSheets

1 fitted, 1 flat, and 2 pillow cases.  
SM #8007427  
MD #8007428



### SunBelt™

Flexible LED light strip with Velcro attachments (power source not included).  
#8007426



### Annex

3-wall changing room or gear enclosure.  
SM #8007421  
MD #8007422

## RoadShower™

### ROOFTOP SHOWER AND WATER STORAGE

Sandy feet, dirty paws, and mud slung bikes. The RoadShower is your trusty side kick for the convenience of pressurized water in the middle of nowhere. Its dependable attachment to your vehicle or trailer allows you to roam freely. And, while you're out having fun, the sun heats up the water in the tank. Check the thermometer and you can enjoy a hot shower, or blast off mac-n-cheese from campsite dishes.

- Built strong with welded aluminum construction and durable powder coat finish
- Large top-cap allows for easy filling
- Pressurize the tank through the Schraeder air valve or a garden hose
- Pressurize with hand or electric pump - Built in pressure relief valve safely and automatically tops out at 65 psi (max)
- Included garden hose adapter harnesses the pressure of your home water spout and fills and pressurizes at the same time.
- Includes a stick-on thermometer strip for the outside of the tank
- Locks to roof rack with included SKS Locks for added security
- Stainless steel universal crossbar attachment - Easily adjustable back and forth for the right fit



Feature	4G #8004109	7G #8004110	10G #8004111
Capacity	4 GAL.	7 GAL.	10 GAL.
Weight (Filled)	53 Lbs.	84 Lbs.	120 Lbs.
Length	55 Inches	55 Inches	82 Inches
Hose Length	55 Inches	55 Inches	81 Inches
Fittings	Nickel Zinc		
PSI (max)	65 psi		

\*Use EXO RoadShower Kit to attach the RoadShower 4G and 7G to your EXO system giving you more mounting options for your RoadShower.

EXO RoadShower Kit #8004112





## SlimShady™ ROOF RACK-MOUNTED AWNING

Don't let its low-profile fool you: this awning packs small and delivers big. From sideline cheers to ridge line views, the SlimShady offers excellent protection from searing sun and sudden showers. It mounts quickly and easily (no tools needed!) to your roof rack crossbars, and only takes up six inches of bar space leaving plenty of room for cargo boxes, bikes, or boats. Super easy to use—just roll it out and set-up the poles—its light, strong polyester canopy has a waterproof PU coating to shed rain and serve up plenty of shady coverage on summer days. Available in three sizes, so you're covered no matter how far, or near, your adventures take you.

- 8' -#8007446
- 6.5' -#8007445
- 4.5' -#8007444



### Awning T-slot Bracket AWNING ACCESSORY

Go sleek with this low-profile t-slot awning bracket and mount up your awning with more options.

#8004113



No tools necessary for install with the easy-to-use SpinVice clamp.



Rolls up into a convenient and durable zippered pouch.

# FISH

**YAKIMA**  
TAKE IT EASY.

LEARN MORE AT [YAKIMA.COM](http://YAKIMA.COM)



## FISHING ROD CARRIER HATCH CLEARANCE TIPS

To find the best fit for your rod carrier, use the measurement in figure 2 to find the necessary distance for your product. The measurements may require you to adjust your crossbars. Do NOT adjust BaseLine Tower Systems.

**Adjustable Roof Rack Systems:** TimberLine Towers, SkyLine Towers\* with Tracks, RidgeLine Towers\*, OverHaul HD, OutPost HD, BedRock HD, BedRock, Outdoorsman, and most Factory Roof Racks.

\*Some vehicles have a fixed crossbar spread, check yakimatech.com for your vehicle's crossbar capabilities in the measurements section.

### Measure Distance

From the front crossbar, measure from the center of that crossbar to the edge of the open trunk hatch. Make sure that you are measuring across the flat surface of the crossbars.

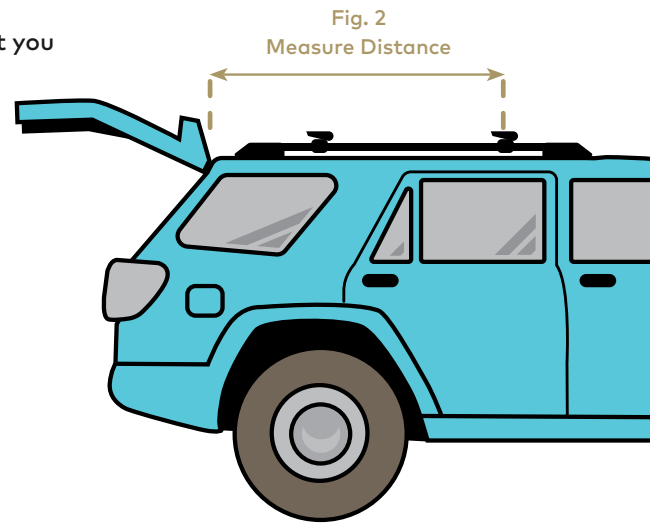

Product	Minimum Distance	
DoubleHaul	57"	144.78 cm
TopWater	54"	137.16 cm

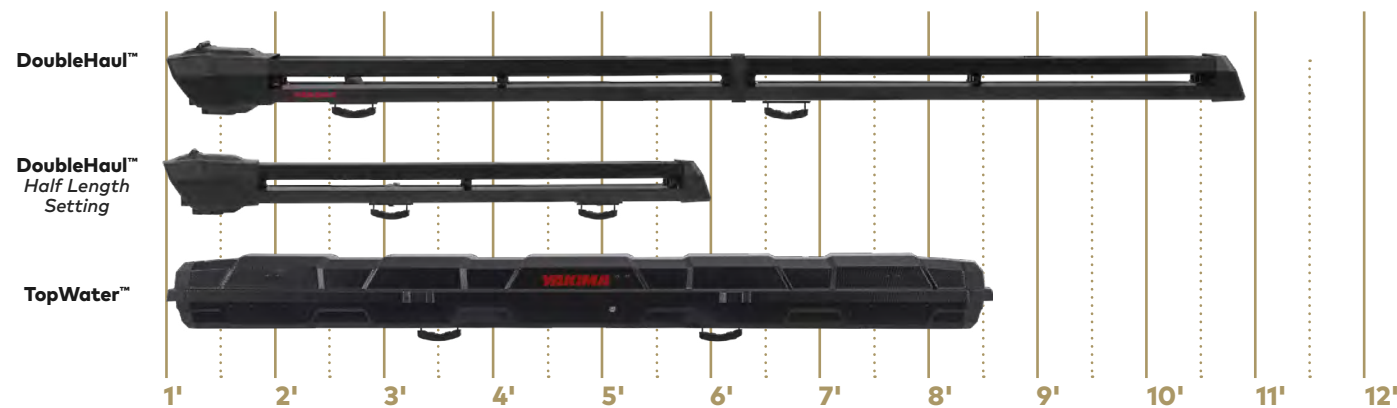

## FISHING ROD CARRIER COMPARISON



# FISHING ROD CARRIERS

## THE FASTEST WAY TO TIGHT LINES

Whether you live to stalk trout in mountain streams, chase bass in a kayak or tangle with finned foes in the salt, our maiden collection of rod carrying solutions is specifically crafted for big catches and easy releases. We took our time designing, testing and building each product so you can load up with ease and haul with confidence.

	FLY	FLY/SPIN	FLY/SPIN
	<p><b>DoubleHaul™ Premium Rooftop Fly Rod Carrier</b> Carry up to 4 fully strung fly rods. Including spay and fighting butts.</p> <ul style="list-style-type: none"> <li>Modular capabilities</li> <li>Full Length: Rods up to 10ft.</li> <li>Half Length: Rod Sections up to 63"</li> <li>Universal crossbar attachment</li> <li>Locks to roof rack; locks rods inside</li> <li>Plastic lined individual steel tubes protect rods</li> </ul>  <p>#8004087</p>	<p><b>TopWater™ Fishing Rod Carrier</b> Carry up to 8 fully rigged up fishing rods inside this in this cargo box built for rods.</p> <ul style="list-style-type: none"> <li>Rod Length: 8ft.</li> <li>Universal crossbar attachment</li> <li>Locks to roof rack; locks rods inside</li> <li>Rubber retention straps stabilize rods on foam struts</li> <li>Removable foam struts for 4-season use</li> </ul>  <p>#8004088</p>	<p><b>ReelDeal™ Rooftop Fishing Rod Mount</b> Easily carry up to 8 fishing rods on just about any vehicle roof with crossbars.</p> <ul style="list-style-type: none"> <li>Universal crossbar attachment</li> <li>Locks rods when closed</li> <li>Rubber clamps protect rods</li> <li>Can be used for skis and snowboards in the off-season</li> </ul>  <p>#8004089</p>
<b>ROD CAPACITY</b>	<b>4</b> Break down when using at half length.	<b>8</b> Up to 8-ft. long	<b>8</b>
<b>FULLY LOCKING</b>	✓	✓	✓
<b>ELEMENT PROTECTION</b>	✓ Rods are fully enclosed at all times.	✓ Rods are fully enclosed at all times.	
<b>LOAD FULLY RIGGED RODS</b>	✓ Including rods, reels, and flies.	✓ Including rods, reels, and lures.	✓





## DoubleHaul™ ROOFTOP FLY ROD CARRIER



Like the perfect cast, the deluxe DoubleHaul rooftop fly rod carrier gets you to that special spot on the water at dawn or off to that mid-day hatch. You're there and ready with the perfect set-up: up to 4 fully strung-up rods up to 10 ft. long. Rain or shine, your rods are securely locked and protected from the elements. The reel box is designed to protect and fit most reel sizes, with space to carry up to 2 spey rods. To make things even easier, the DoubleHaul mounts to most roof racks with a simple, tool-free universal crossbar attachment. With modern styling and a unique half-length configuration, it's a perfect fit on any size vehicle. Be ready to hit the water when the fish are biting.

- Transports 4 fully strung-up fly rods up to 10 ft. long
- Custom-fitted felt padding for premium reel protection
- The top 2 reel slots fit most 12-wt. reels and spey rods
- The bottom 2 reel slots fit most 10-wt. reels
- Reel box holds common fighting butts of single-handed rods
- Four individual plastic-lined aluminum rod tubes provide strength and separation for rods while helping prevent abrasion
- Side placement of reels reduces wear on rod-stripping guides and eyelets
- Universal mounting hardware fits all Yakima® crossbars and most other roof racks
- For an even sleeker profile add the SmarT-Slot™ Kit 3 to attach to a T-slot crossbar (sold separately)

#8004087



Configurable at either 11 ft. or 6 ft. to accommodate different vehicle lengths.



Reel box holds up to 2 spey rods in upper slots.



Includes Yakima® SKS Locks to secure rods inside and lock DoubleHaul to roof rack.



## TopWater™ FISHING ROD CARRIER



Ready to go when the fish are biting, the TopWater is a purpose-built, enclosed fishing rod box—keeping you prepared to hit the water with up to 8 fishing rods, up to 8 ft. long—fully rigged, organized, and out of the vehicle. From spin to bait casting to fly rods, the protective foam pads and retention straps keep rods and reels safely suspended in place without getting banged around or entangled. The space below your rods makes room for low-profile tackle boxes or other wet gear. This strong and rugged fishing rod box locks your gear inside and the box to your roof rack. For added ease, the universal attachment secures the TopWater to nearly any roof rack or Yakima's® EasyRider™ and RACKandROLL™ trailers.

- Carry up to 8 fully rigged-up fishing rods of any style, up to 8 ft. long
- Keeps wet rods out of the vehicle, organized, and set up for the day
- Protective foam pads—designed with individual rod slots
- Small drain holes help prevent water from pooling in bottom of the box
- Removable rod holders for 4-season transport of skis and other long gear
- Made in the USA with a sleek, aerodynamic Carbonite®-textured lid
- Universal mounting hardware fits all Yakima crossbars and most other roof racks
- Add the SmarT-Slot™ Kit 5 to attach to a T-slot crossbar for an even sleeker profile (sold separately)
- 50-lb. max weight capacity
- 18" total width leaves plenty of room for fishing kayaks or other gear on your roof rack

#8004088



Side opening for easy access to rigged-up fishing rods.



Rubber retention straps secure rods in place.



Built-in rod shields protect rod tips from damage.



Built-in Yakima SKS Locks secures rods inside and locks TopWater to roof rack.





## ReelDeal™ ROOFTOP FISHING ROD MOUNT



Simple and compact, the ReelDeal fishing rod mount securely carries up to 8 full-length fishing rods of just about any style on your roof rack—instead of in your vehicle. It's the safe, easy way to transport your rods fully rigged-up and ready to fish. The single-button side access makes for quick loading/unloading and the included SKS (Same Key System) locks keep your rods safe and secure.

- Carries up to 8 fully rigged-up fishing rods of just about any style
- 15.5" of full-length padding securely holds and protects rods
- Tool-free clamp design makes install and removal a breeze
- Universal mounting hardware fits all Yakima® crossbars and most other roof racks
- Integrated SKS Locks secure rods in the rack
- ReelDeal™ also can transport up to 2 snowboards and/or 4 pairs of skis

#8004089



Carries up to 8 fully rigged-up fishing rods of just about any style.



Rubber pads protect rods and hold them securely in place.



Integrated SKS Locks secure rods in the rack.



## TRAILERS

**YAKIMA**  
TAKE IT EASY.



# EASYRIDER TECHNICAL SPECS

## WEIGHT LIMIT

TOP DECK = 350 lbs  
 BOTTOM DECK = 500 lbs  
 TOTAL WEIGHT LIMIT = 500 lbs

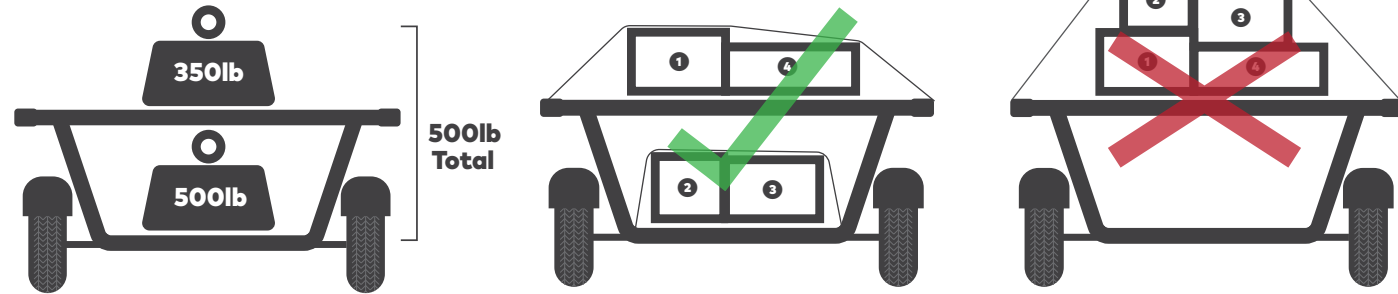

## SPEED LIMIT



## SPECIFICATIONS

GVWR: 675 LBS  
 TIRE SIZE: 135/90-12  
 LUG NUT SIZE: M12 X 1.5  
 EMPTY WEIGHT: 175 LBS  
 THIS INFORMATION CAN ALSO BE FOUND ON THE VIN PLATE.

## CUSTOMER SERVICE

888-925-4621 or support@yakima.com

## REPORTING SAFETY DEFECT

If you believe that your Yakima EasyRider trailer has a product defect which could cause a crash or cause injury or death, you should immediately inform the National Highway Traffic Safety Administration (NHTSA) in addition to notifying Yakima Products, Inc.

NHTSA Headquarters  
 1200 New Jersey Avenue SE.  
 West Building  
 Washington, DC 20590  
 Toll-Free: 888-327-4236  
 Hearing Impaired (TTY): 800-424-9153

## USDOT

General Information Main Switchboard  
 202-366-4000 / Mon-Fri, 8:30AM - 5:30PM EST  
 excluding Federal Holidays.

## CANADA DOT

Canadian Customers who wish to report a safety defect should contact: Transport Canada Defect Investigations  
 1-800-333-0510 or 819-994-3328 (Gatineau-Ottawa area or internationally).



## EasyRider™ PREMIUM TWO-LEVEL TRAILER

With a 500-lb. load capacity, now you won't have to leave behind your favorite activities and gear! Up top and down below, the EasyRider gear trailer is the easy way to get to your next adventure with everything you want to haul. Whether it's big fishing kayaks, bikes, baskets, cargo boxes, or a rooftop tent, you're there! It's made with lightweight aluminum, so you can still use it as a handcart to get your kayaks to the water's edge. The EasyRider trailer is equipped with our widest, burliest HD bars and accepts any Yakima mount. What's more, the foldable tongue makes storage a snap.

#8008129



## EASYRIDER ACCESSORIES



**Spare Tire Kit**  
 Spare Tire for EasyRider Trailer. Includes steel wheel, tubeless tire, mounting bracket, and all hardware.

#8008125



**Tent Kit**  
 Convert the EasyRider™ trailer to a stand-alone Skyrise™ tent platform. Includes 2 jack stands and 2 wheel chock sets.

#8008127





## RACKandROLL™

### TRAILER

Never be forced to choose between your favorite activities and gear. Maximize your gear-hauling choices by adding a sturdy, lightweight trailer. The RACKandROLL trailer is made of lightweight aluminum and offers a stable, secure ride for all your gear. Stores easily upright in the off-season.

- Lightweight aluminum construction
- Shock absorbers provide 4" of independent wheel travel
- Stores easily in compact upright position with removable wheels and tongue
- Small wheels on rear of trailer for easy storage
- Carrying capacity is 250 lbs. with stock suspension

RACKandROLL 66 #8008106

RACKandROLL 78 #8008107



66



78

### RACKANDROLL ACCESSORIES



**Heavy-Duty Shocks**  
#8008110  
RackANDRoll 78" Only



**Kick Stand**  
#8008115



**5 Spoke Spare Tire**  
#8008121



# SNOW







### FatCat™ EVO PREMIUM SKI & SNOWBOARD MOUNT

Our most aerodynamic and premium-styled snowsport mount. A wider base allows for fat skis and snowboards. Optional super-low-profile T-slot hardware accessory sold separately.

- 4 SKIS/2 BOARDS #8003095
- 6 SKIS/4 BOARDS #8003096



FatCat EVO 6



FatCat EVO 4



**SmarT-Slot Kit 2**  
T-slot adapter kit for streamlined look.  
#8003098



### SKI AND SNOW MOUNT COMPARISON

	Mount Style	Number of Skis	Number of Boards	Locks To Vehicle	Locks Clear	Tool-Free Install	Fully Assembled	Built in Ski Lift	Premium Look	Product Weight (lbs.)
FatCat EVO 4	Clam Shell	4	2	✓	✓	✓	✓	✓	✓	10
FatCat EVO 6	Clam Shell	6	4	✓	✓	✓	✓	✓	✓	12.75
FreshTrack 4	Clam Shell	4	2	✓	✓					6
FreshTrack 6	Clam Shell	6	4	✓	✓					8
HitchSki	Hitch Conversion	6	4	* ✓	✓	✓		N/A		29

\* With Bike Locking Rack



Large locking button is easy to use with gloves on and secures your gear and the rack.



OverHang™ mounting location makes it easier to load up.



Integrated SkiLift creates clearance for tall bindings.



Universal hardware works on just about every roof rack.





## FreshTrack™

### SKI & SNOWBOARD MOUNT

The perfect mount for loading the crew and hitting the slopes. It features easy, gloves-on operation and includes built-in locks.

4 SKIS/2 BOARDS #8003092  
6 SKIS/4 BOARDS #8003093



## HitchSki™

### SKI & BOARD CONVERSION MOUNT FOR BIKE HITCH RACK

Bike in the summer, ski in the winter. The HitchSki converts your 4 or 5 bike tilt or swing-style hitch rack into a ski and snowboard carrier with ease.

#8002418



## BUILD YOUR ROOF RACK

### SMARTPHONE - GO.YAKIMA.COM

DESKTOP - YAKIMA.COM and follow steps to "Add Your Vehicle"

## BUILD YOUR EXO SYSTEM

### SMARTPHONE - GO.YAKIMA.COM

YAKIMA.COM and follow steps to "Add Your Vehicle", then shop EXO

## TECHNICAL PRODUCT AND VEHICLE FIT INFORMATION

### YAKIMATECH.COM

## CUSTOMER SERVICE

888-925-4621



# **YAKIMA**®

**TAKE IT EASY™**



@YAKIMARACKS

YAKIMA PRODUCTS  
4101 Kruse Way  
Lake Oswego, OR 97035-2541  
Yakima.com  
888.925.4621

PRICES ARE SUBJECT TO CHANGE.  
All images and content are produced and copyrighted by Yakima Products Inc.  
Yakima Products Inc. reserves the right to update and discontinue the use of  
specific assets. Yakima is a registered trademark of Yakima Products, Inc.

LEARN MORE AT [YAKIMA.COM](http://YAKIMA.COM)