



SUMMER SALES MEETING SP23

YAKIMA

Today's New World

CHANGE IS CONSTANT

- New factors of the world economy
- New inventory demand levels
- New purchasing patterns
- New vehicles, gear & activities

CONSTANTLY ADAPT FOR GROWTH

- Creation of new categories
- Reinforcing the core

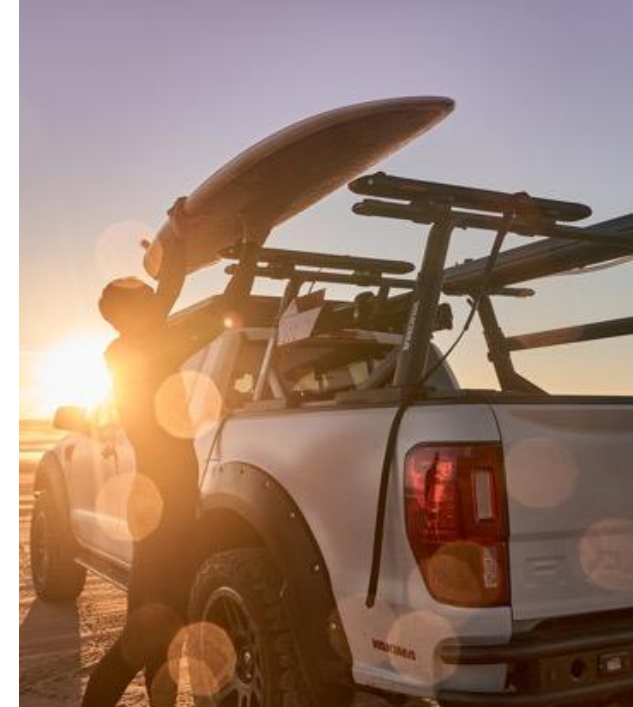

Balanced Growth

New Category Growth

Core Category Growth



StreamLine System

2016



HD Truck Racks

2017

SkyRise & SlimShady



2019

Fishing



LockNLoad



RoadShower



HangOver



OnRamp

2020



Cargo Boxes



EXO System

2021



StageTwo

HangTight



OpenRange



StreamLine FX



2023+

Forging Ahead

BALANCED GROWTH

- Adapting to the changing world
- Adapting to the changing user

INNOVATING FOR GROWTH

- Creation of new categories
- Reinforcing the core





SP22 PRODUCT

UPDATES

EXO OpenRange

SUMMER LAUNCH

- Great response from market & media
- Production delays due to COVID in China

EXO OpenRange

- Begin shipping by end of June

EXO OpenRange Deluxe & Accessories

- Begin shipping by end of July



StreamLine & FX

StreamLine

- New SightLine & SightClips
- New cover-versions of BaseLine, SkyLine, & TimberLine
- **On track for 8/15/2022 ATS**

StreamLine FX

- SightLine FX, BaseLine FX, SkyLine FX, TimberLine FX
- **ATS in Feb/2023**





SP23 PRODUCT

INTRODUCTION

Sp23 Collection

Reinforcing the Core

Cargo

SkyBox NX
Cargo Accessories
CBX Solar

Roof Racks

StreamLine FX
Track Tower
LNL Size C

BaseCamp

MajorShady 270 Awning



SP23 PRODUCT

NEW CARGO LINE

SkyBox NX

Completely new MidPrice Cargo line with updated aesthetics, new mounting hardware & better hatch clearance

- New Aesthetics – updated looks to better integrate with modern vehicles & industry 1st texture on lid *AND* base
- Proven Mounting Hardware – GrandTour / CBX mounting hardware, including torque tool trickles down to SkyBox NX level cargo box line
- Better Hatch Clearance – improved hatch clearance = larger boxes being able to fit on vehicles without hatch contact (*BEST in MARKET*)

SkyBox NX

Combination of features & updated looks along with open / close operation better than the competition will recapture 50%+ of the most important segment of the cargo box market.





SkyBox NX

- Spring 2023 SkyBox NX 16 and SkyBox NX 18
- Additional sizes to follow in Spring 2024

SkyBox NX

Product Features

Best-in-Market and First-in-Market features makes SkyBox NX difficult to beat. Extensive concept validation was done in early 2021 to determine the feature set.



- Best-in-market hatch clearance for both sizes



- First-in-market textured base matches lid nano- texture



- Full metal opening handle stands out from the competition



- Low internal mounting hardware with removeable torque tool

SkyBox NX

Product Features

Best-in-Market and First-in-Market features makes SkyBox NX difficult to beat. Extensive concept validation was done in early 2021 to determine the feature set.



- Design matches modern vehicles



- Removable torque tool does not take up valuable cargo space



- New lid structure designed for stiffness and storage capacity



- Dual-sided opening for easy access on either side of the vehicle



SkyBox NX 16

Perfect for shorter roof lines and CUVs, this box will become the go to for hard to fit vehicles as it will fit on most anything with crossbars.



SkyBox NX 18

This becomes the ski box in the line with the ability to carry 195cm ski along with best-in-market hatch clearance.



SkyBox NX 12 & 21

Coming Spring 2024



Product Persona

SkyBox NX

Core Outdoor / Active Family



Product Essence:

The last cargo box you'll ever need

Functional Benefits:

- Versatile – This cargo box takes it all
- Reliability – SkyBox NX is built to last a lifetime
- Capacity – Tons of space to carry your gear

TARGET DEMOGRAPHIC:

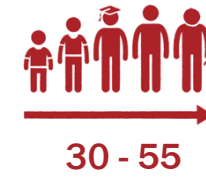

30 - 55



Family

INTERESTS & HOBBIES:



Camping



Travel



Biking

TRUSTED RESOURCES FOR BUYING DECISIONS:



Consumer Reviews
(e.g. REI)



Recommendations
(friends, riding buddies, etc.)

Outside

Outdoor Industry Publications (e.g. Outside Mag)

KEY FEATURE: Best bang for the buck in cargo boxes

VEHICLE SET-UP:



Toyota
4Runner



HoldUp EVO



Cargo Box and
Bikes



SkyBox NX 16





SkyBox NX 16

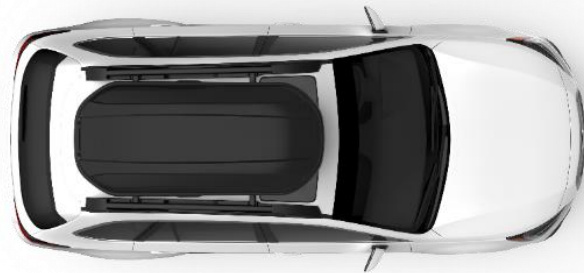



SkyBox NX 18



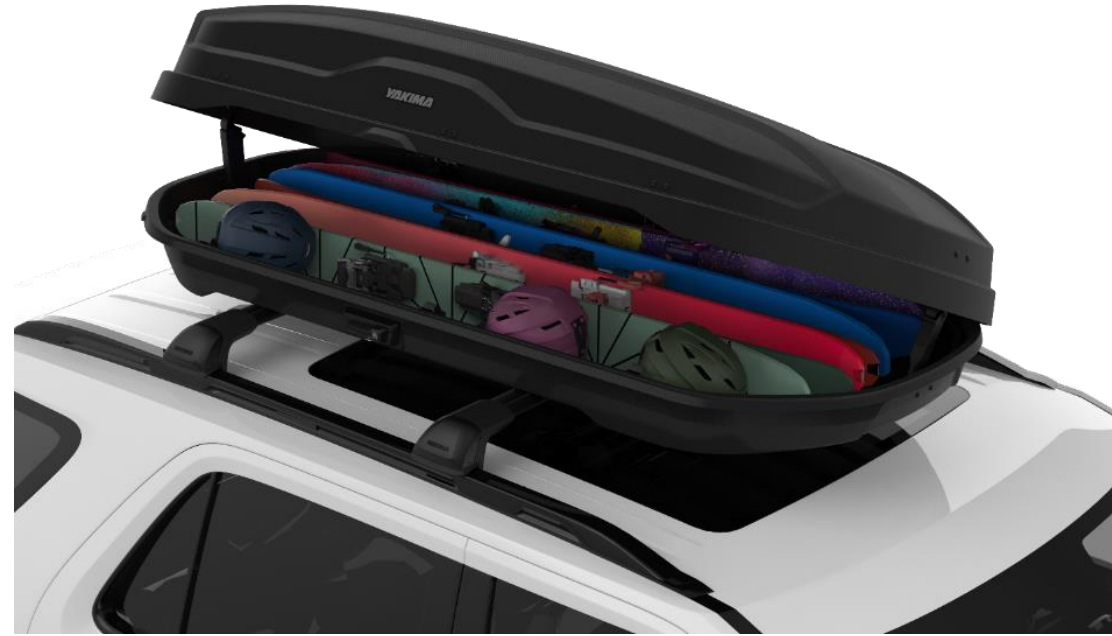

SkyBox NX 18

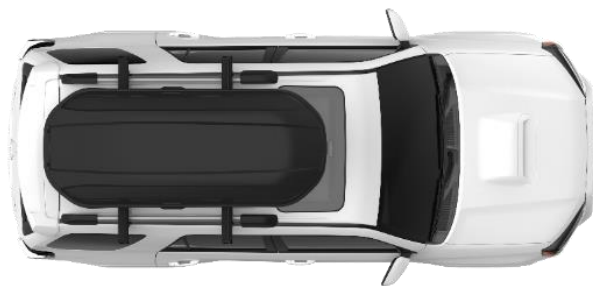

SkyBox NX nano-texture





Competitive Landscape

	Thule	Yakima
\$1499+	Vector Alpine Vector	CBX Solar
\$900-\$1079		CBX
\$779-\$899	Motion XT	GrandTour
\$629-\$819	Force XT	SkyBox NX SkyBox
\$499-\$599	Pulse	RocketBox Pro DeepSpace

SkyBox Landscape

2023	2024
SkyBox 21 Carbonite \$819	SkyBox NX 21
SkyBox NX 18 \$799	SkyBox NX 18
SkyBox NX 16 \$749	SkyBox NX 16
SkyBox 12 Carbonite \$669	SkyBox NX 12





SkyBox NX 16 & 18





SkyBox NX 16 & 18

- NX 16 - \$749 MSRP
- NX 18 - \$799 MSRP
- 2/15/2023 ATS

- Additional sizes to follow in Spring 2024

SkyBox NX Transition Plan

- NX replaces Carbonite 16 & 18 on price list
- SkyBox 12 & 21 remain on price list for all of 2023
- Transition dealers to NX for Spring 2023 for 16 & 18 sizes
- Why switch to NX?
 - ✓ Improved hatch clearance
 - ✓ Improved install experience
 - ✓ Box line efficiencies = improved capacity = product availability
 - ✓ Improved aesthetics



SkyBox NX Cargo Liner

Product Features

Feels like a custom floor mat for your SkyBox NX.



- Custom fit and available for SkyBox NX 16 & SkyBox NX 18



- Helps to protect ski edges



- Easy to remove for simple clean up



SkyBox NX Cargo Liner

- 2/15/2023 ATS

SmarT-Slot Kit 6

Product Features



T-Slot kit for SkyBox NX, CBX and GrandTour so you can T-Slot mount your cargo box for a super clean look.



- All the parts needed to t-slot mount your cargo box



- Uses torque limiting tool for perfect install



- Super clean look with no claw visible



SmarT-Slot Kit 6

- 2/15/2023 ATS
- Works for all sizes of CBX, GrandTour and SkyBox NX





CBX Solar 53W

Product Features

Yakima has teamed with Merlin Solar to provide a more powerful panel and additional output. Now with 2 USB-A and 1 USB-C outputs.



- New solar panel is tougher and more powerful



- Updated control box will have an additional USB-C output





CBX Solar 53W

- 2/15/2023 ATS
- Improved cargo box, same price
- New part number, 8007500



CATEGORY	PRODUCT	NEW / TRANSITION	ATS
CARGO	SkyBox NX 16	REPLACEMENT	Feb/2023
CARGO	SkyBox NX 18	REPLACEMENT	Feb/2023
CARGO	CBX Solar (53W)	REPLACEMENT	Feb/2023
CARGO	SkyBox NX 16 Cargo Liner	NEW	Feb/2023
CARGO	SkyBox NX 18 Cargo Liner	NEW	Feb/2023
CARGO	SmarT-Slot Kit 6	NEW	Feb/2023

A dark, atmospheric photograph of a dense evergreen forest. The trees are silhouetted against a misty, grey background, creating a sense of depth and mystery. The lighting is low, emphasizing the textures of the needles and the verticality of the trunks.

SP23 PRODUCT

LOCKNLOAD PLATFORM



ROOF RACK

LNL Size C

New size, same great platform

- 76" long by 54" wide (length of J & width of B)
- Fits current generation 4Runner with LP29
- Will be a great size for mid sized SUV fits
- Rail Kit C also available
- Target ATS 2/15/2023

Lineup Change

- Platform H (84" x 62") will transition out of the line



Size Range & Pricing For Spring '23

Name	Size L x W	LNL MSRP*	Rail Kit MSRP*
LockNLoad, Size K	55" x 49"	\$799	\$239
LockNLoad, Size B	60" x 54"	\$849	\$249
LockNLoad, Size C	76" x 54"	\$999	\$259
LockNLoad, Size J	76" x 65"	\$979	\$269
LockNLoad, Size E	84" x 49"	\$999	\$279
LockNLoad, Size N	84" x 54"	\$999	\$279

*Prices reflect July 2022 Pricing



SP23 PRODUCT

TOWERS: HD LINE

Market Opportunity

TOWER LINEUP

SkyLine Towers and Landing Pads

The SkyLine tower with Landing Pad is a proven and great system with premium features like pitch adjustment and quick on/off.

Market demand

There has been call from the truck canopy industry and rack specialty for a simplified yet strong tower that can fit into tracks.

Flat roofs and other applications

Not all tracked applications require pitch adjustment.

Not all customers need or want quick release rack systems.

Low is good

Low profile systems are the trend for aftermarket roof rack and platform systems.

Closer to the roof while remaining functional is the consumer demand.



ROOF RACK

TrackTower

Low Profile HD Towers for Tracks

- Low Profile - stands 2" off of tracks
- Compatible with all Yakima crossbars and LockNLoad
- Strong – 165lb Capacity / 220lb w/ HD Bar Or LNL
- Fully off road rated
- Everything for mounting is in the box
- Cost less than SkyLine with Landing pads





ROOF RACK

TrackTower

- 4 Pack
- 2 Pack

*Bulk SKU Available 2023





ROOF RACK

Landing Pad 31

- Fits 2021+ Nissan Rogue w/ flush rails
- Load Limit – 165lbs, 220lbs w/ HD Bar
- 4 Pack
- Target ATS – 11/15/2022





ROOF RACK

CATEGORY	PRODUCT	NEW / TRANSITION	ATS
ROOF RACKS	BaseLine FX (6 lengths)	NEW	Feb/2023
ROOF RACKS	SightLine FX (4 lengths)	NEW	Feb/2023
ROOF RACKS	SkyLine FX (7 lengths)	NEW	Feb/2023
ROOF RACKS	TimberLine FX (5 lengths)	NEW	Feb/2023
ROOF RACKS	TrackTower (4-pack)	NEW	Feb/2023
ROOF RACKS	TrackTower (2-pack)	NEW	Feb/2023
ROOF RACKS	TrackTower, Bulk (12 sets of 4)	NEW	Feb/2023
ROOF RACKS	LockNLoad, Size C	REPLACEMENT	Feb/2023
ROOF RACKS	LNL Perimeter Rail Kit, Size C	REPLACEMENT	Feb/2023
ROOF RACKS	Landing Pad 31 (Nissan Rogue 2021+)	NEW	Nov/2022



SP23 PRODUCT

BASE CAMP

MajorShady 270

Roof Mounted 270 Awning



MajorShady 270

Roof Mounted 270 Awning

- Deploys around side and rear of vehicle (LH & RH)
- 80 sq. ft. of coverage
- Sturdy aluminum truss support arms
- Support legs and guy lines included
- 420D poly-cotton fabric with waterproof coating
- Yakima topo fabric pattern
- T-slot mounting brackets included
- Rugged dual-zippered travel bag

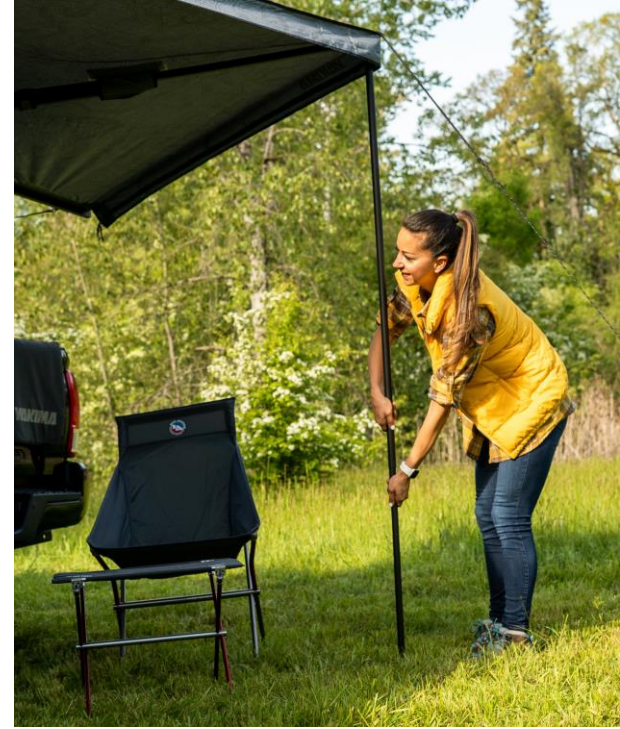

MajorShady, Single Wall Kit

MajorShady Accessory Wall

- Zippered single wall panel sold separately
- Attaches on any side edge of awning for weather coverage
- Includes adjustable height poles, stakes, and guy lines
- Hook and loop attachment on sides to connect additional walls
- Same topo pattern as awning





MajorShady 270

CATEGORY	PRODUCT	NEW / TRANSITION	ATS
BASE CAMP	MajorShady 270, RH	NEW	Feb/2023
BASE CAMP	MajorShady 270, LH	NEW	Feb/2023
BASE CAMP	MajorShady Single Wall Kit	NEW	Feb/2023



SP23 PRODUCT

LAUNCH SUMMARY

Sp23 Collection

Reinforcing the Core

Cargo

SkyBox NX
Cargo Accessories
CBX Solar

Roof Racks

StreamLine FX
Track Tower
LNL Size C

BaseCamp

MajorShady 270 Awning

Sp23 Collection



CATEGORY	PRODUCT	NEW / TRANSITION	ATS
CARGO	SkyBox NX 16	REPLACEMENT	Feb/2023
CARGO	SkyBox NX 18	REPLACEMENT	Feb/2023
CARGO	CBX Solar (53W)	REPLACEMENT	Feb/2023
CARGO	SkyBox NX 16 Cargo Liner	NEW	Feb/2023
CARGO	SkyBox NX 18 Cargo Liner	NEW	Feb/2023
CARGO	SmarT-Slot Kit 6	NEW	Feb/2023
ROOF RACKS	BaseLine FX (6 lengths)	NEW	Feb/2023
ROOF RACKS	SightLine FX (4 lengths)	NEW	Feb/2023
ROOF RACKS	SkyLine FX (7 lengths)	NEW	Feb/2023
ROOF RACKS	TimberLine FX (5 lengths)	NEW	Feb/2023
ROOF RACKS	TrackTower (4-pack)	NEW	Feb/2023
ROOF RACKS	TrackTower (2-pack)	NEW	Feb/2023
ROOF RACKS	TrackTower, Bulk (12 sets of 4)	NEW	Feb/2023
ROOF RACKS	LockNLoad, Size C	REPLACEMENT	Feb/2023
ROOF RACKS	LNL Perimeter Rail Kit, Size C	REPLACEMENT	Feb/2023
ROOF RACKS	Landing Pad 31 (Nissan Rogue 2021+)	NEW	Nov/2022
BASE CAMP	MajorShady 270, LH	NEW	Feb/2023
BASE CAMP	MajorShady 270, RH	NEW	Feb/2023
BASE CAMP	MajorShady Single Wall Kit	NEW	Feb/2023

Product Samples

INITIAL APPEARANCES

- First samples for SSM and GOA
- Leverage toolkit for initial sell-in meetings
- Show samples at Big Gear Show, Aug. 3rd

FULL SAMPLE DISTRIBUTION

- Waiting for production level samples
- SkyBox NX – seeding samples in September
- 270 Awning – seeding samples in September



Product Timing

PRODUCT TOUCHPOINTS

1

SSM

Yakima Summer Sales Meeting
June 2, 2022

Sell-in Toolkit

Videos, digital files,
Digital Showroom,
June 2

Printed items, June

2

Sales Samples

Limited use at regional shows

Production Samples available in Sept.

3

Big Gear Show

Yakima booth in Park City, Aug. 2-3, 2022

4

SEMA

Yakima booth in Las Vegas, Nov. 1-4, 2022

5

Sp23 ATS

Begin shipping orders in by Feb. 15, 2023

YAKIMA®



LAUNCH ALIGNMENT

2022 GTM Trade Dates

Event		Dates	Location
Yakima Business Update	✓	February 15, 2022	Brandlive, Yakima HQ
Retailer Product Advisory	✓	March, 2022	Zoom
Yakima Spring Media Event	✓	March, 2022	Verde Agency - Virtual
IFTD Fly Fishing Show (S22/DBHL)	✓	3/30-4/1, 2022	SLC, UT
Summer Sales Meeting (Spring '23)		June 3, 2022	Virtual, Yakima HQ
GOA Spring		June 6-9, 2022	Knoxville, TN
Regional Rep Shows/Events		June-August, 2022	Various
Big Gear Show		August 2-3, 2022	Park City, UT
SEMA		November 1-4, 2022	Las Vegas, NV



2022 Consumer Events

Event	Dates	Location
Sea Otter Classic	April 7-10 	Monterrey, CA
Gambler 500	June 10-12	Central OR
Overland Expo PNW	July 8-10	Redmond, OR



2023 Consumer Events

Event	Dates	Location
Sea Otter Classic	April	Monterrey, CA
Overland Expo West	May	Flagstaff, AZ
Overland Expo PNW	July	Redmond, OR
Northwest Tune Up	July	Bellingham, WA
Strait Acres Invitational	August	San Diego, CA



Sell-In Tools



S23 B2B Asset Deliverables

	Delivery Date
Line Planner (Digital)	6/2/2022
Price Lists (Digital)	6/2/2022
Dealer Workbook & Tri Fold Collateral Collections (Digital)	6/2/2022
On Demand Sales Meeting/CGI/Product Overview Videos	6/2/2022
NEW Digital Showroom Tool (On Demand)	6/2/2022
SkyBox NX Hype Video	7/1/2022
Print Collateral (DLR WB, TF, Line-At-Glance)	In Production
Product Guide (Print)	2/15/2023
Training Content: Garage Videos	2023
Merchandising/POP/Swag	2022/2023

Print Order Portal

- Pre-Order Portal
 - Efficient, Saves Paper, Saves Money, Easier!
 - Orders Are In – Shipping Direct
- Collateral Review:
 - Dealer Workbook
 - StreamLine
 - Cargo
 - BaseCamp
 - Line-At-Glance
 - Product Guide
 - 2022 Product Guide – In Transit
 - 2023 Product Guide – Planned for Q1/Q2'23

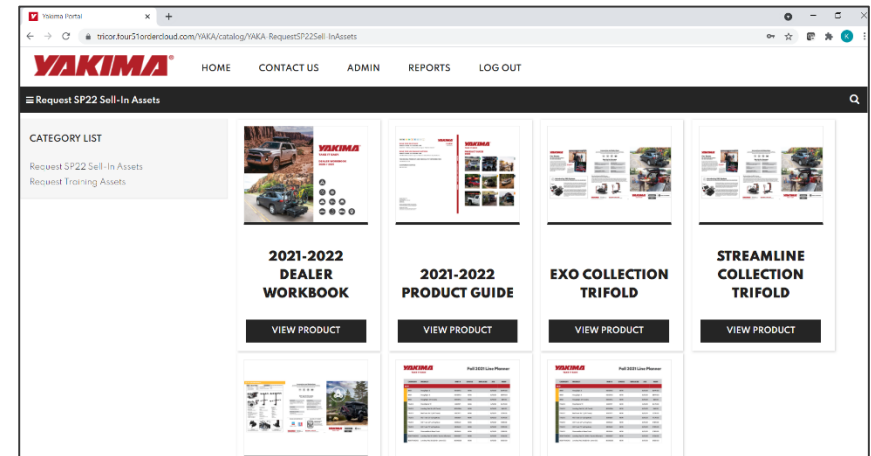
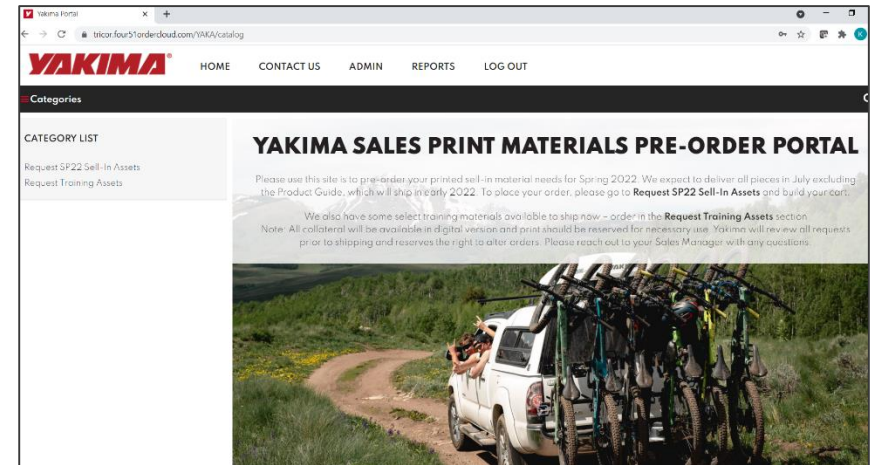

showroom.yakima.com

- Yakima Built and Yakima Owned!
- Digital Showroom Transition Away From BrandLive
- Content Available On-Demand
 - Interactive Product Catalog
 - On-Demand Sales Meeting Content
 - Video Library
 - Digital Resource Download
 - Password Protected
- User Access: Direct or via HUB
- Available NOW!

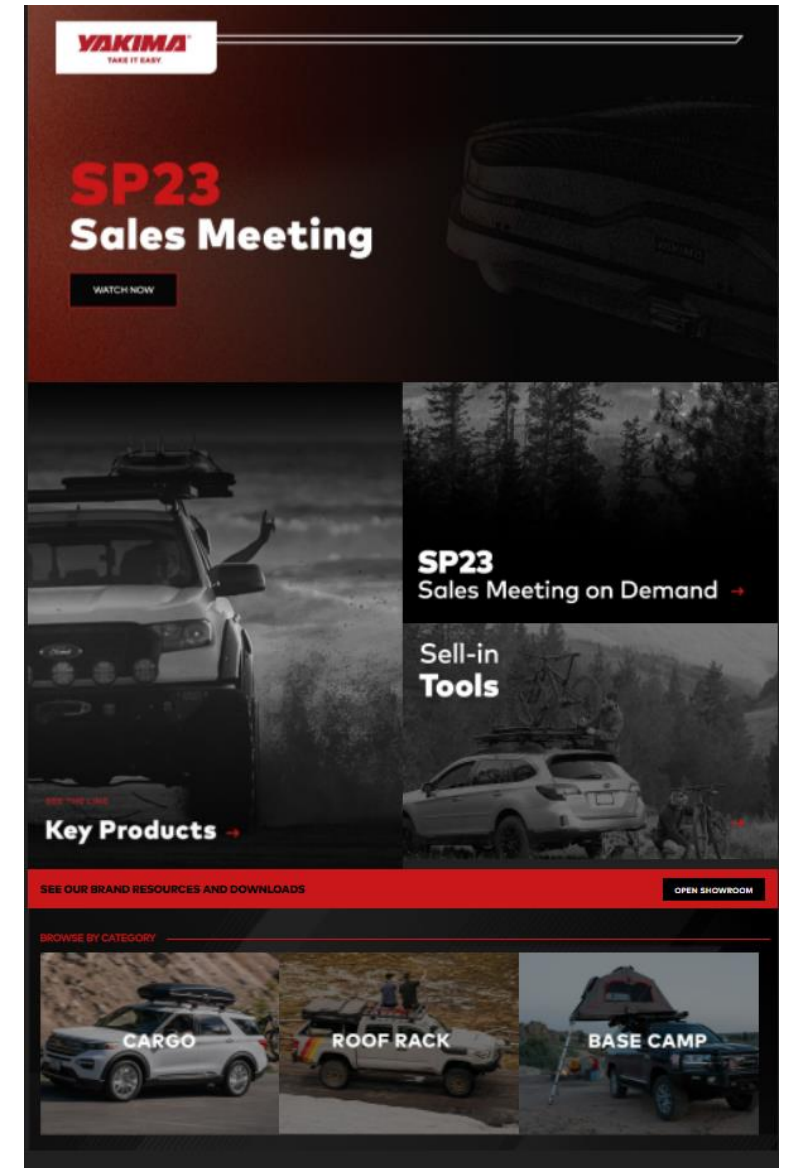



MERCHANDISING

Tool Kit Review

- Tool Kit is live on B2B
 - Documents>Merchandising Information
- Kit Components:
 - Order Form
 - Merch, POP, Field Assets Catalog
 - Swag Catalog
 - Freestanding Display Build Simulators
 - Ordering Process Maps
 - Dealer Service Team Members



Tool Kit Review Ctnd.

- Features:
 - Visual Catalog
 - Augmented Reality
 - Showcase Gallery
 - Fresh Brand Builder Items – POP
 - Fresh Swag – Installer Focused
 - Streamlined Ordering

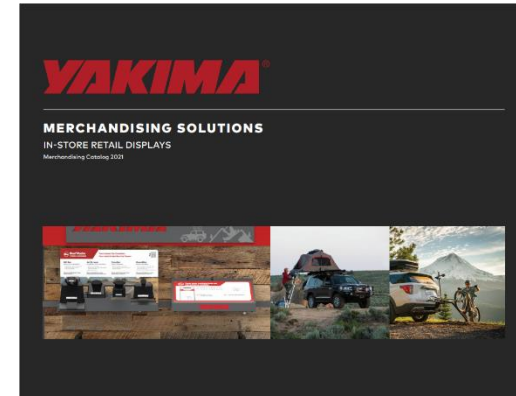

FLOOR DISPLAY SHOWCASE
BIKE DISPLAY

Bike Shop Display Showcase
5 ft Core Display Unit

Part Number	Module Components	Qty
B00987	5 Foot Core Display	1
B00920	5 Foot Power Box	1

SIDE 1 MODULE COMPONENTS

Part Number	Module Components	Qty
B00987	TSC Bike Display**	1
B00927	TSC Bike Display**	1
B00929	Product Card Frame - Top of Car	1
B00925	Product Card - Top of Car Bike 2L Combo	1
Verdes	Lifestyle Graphic	1
Verdes	Yakima Top Bike Rack**	1
B00926	Product Card Frame for Hitch	1
B00927	Product Card - Hitch 2L Combo	1

SIDE 2 MODULE COMPONENTS

Part Number	Module Components	Qty
B00929	Bikes/Car Rack	1
B00925	Informational Graphic	1
Verdes	Informational Graphic Display Graphic	1
B00927	Front Display**	1
B00926	Product Card Frame for Hitch	1
Verdes	Yakima Top Bike Rack**	1

SIDE 3 & 4 MODULE COMPONENTS

Part Number	Module Components	Qty
Verdes	Yakima Top Bike Rack Off Vehicle Mount Bike Rack	1
B00927	Product Card Frame Mount	1

YAKIMA MERCHANDISING SOLUTIONS 2021 **Yakima display unit not included



2022 Merchandising



Large Floor Displays

- A new cargo box display (In-Stock)
- A load-in of EXO and Multi-Hitch Displays (In Stock)

Modular Displays/Slat Wall Components

- New top of car modules (Planned)
- Retrofit/upgrade kits (Planned)

EVA, REI, & Graphics

- Refresh kits, upgrades
- New and updated graphic options

Looking to the Future

- S23 EVA Replacement/Tent Display

Modular Displays

Supporting Recent/Upcoming Launches

Update - StreamLine Module – Q3

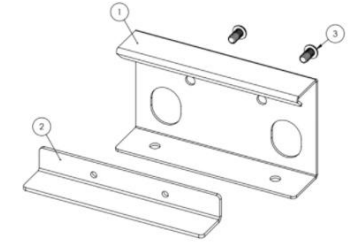

NEW – StreamLine FX Module- Q1'23



NEW – Custom Install Module – Q3



Other Displays

Transitions and New



Update – EVA Fixture – Q3

- Kitted components to update existing
- EVA will no longer be produced or supported beyond this



Update – REI "Atlas" Update/Upgrade- Q3

- Short-term/long-term solutions
- Addresses quality issue as well as new towers, signage/naming

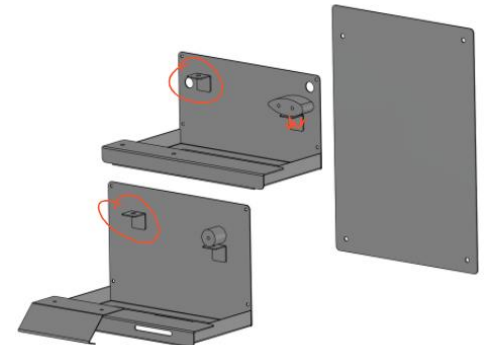
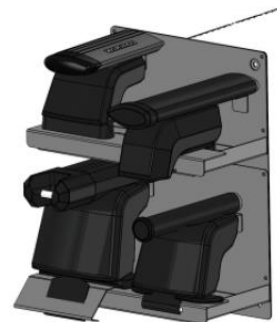

Display Graphics

Updates/New

Update – S22 Bike Hitch Graphic – Shipped

NEW – EXO Hitch Graphic – In Stock

NEW – StageTwo Hero PopUp – Shipped

NEW – OpenRange Hero PopUp – Q3



Swag, POP, Brand Building

- Use those brand builders!



New Apparel : Shirts, Hoodies

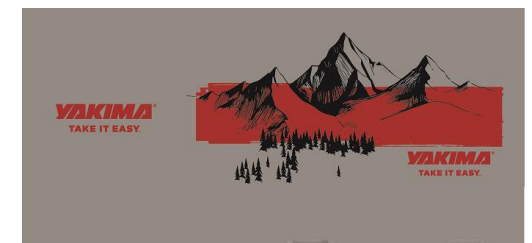
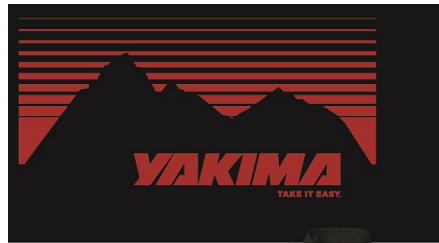

Coming Soon! Q3



YAKIMA®

GARAGE

ONLINE TRAINING

LEARN & EARN

